

HFS Group
Route de Taillepied 44
1095 Lutry
directionhealthsport.ch
+41 21 803 57 67

MEDICAL TROLLEY

HFS Group





CONCEPTS & ADVANTAGES



Standardization Certificates Approval

Obtain ISO9001, 13485, 14001, 18001 quality system certification, TUV approval for CE conformity, US FDA, GB national safety standard qualified enterprises. In accordance with the demand of facility management and environmental safety in JCI



Ergonomic Design

As a member of the mobile terminal system, our medical trolley has a high proportion of science, with a handiness easy push wheel design, make the handle more comfortable. The whole trolley adopts professional seamless design, easy to clean



Nursing Intensity Optimal Design

In accordance with the demand of facility management and environmental safety in JCI. Each trolley with storage capacity can meet the demand of 8-10 beds per day. Trolleys with distinct signs to distinguish different using purposes, realize the classification management of non-medical waste and medical waste, which effectively improve the quality of medical care.



Chromatic Design

The design of medical carts integrated into the medical environment to regulate the mood of nurses and enhance the harmony between doctors and nurses. The chromatic design is according to the 2008 edition of "Guidelines for Hospital Construction in China" issued by the Hospital Management Institute of the National Health and Family Planning Commission, also according to "American Medical and Nursing Space" and "Health Nursing Art Program".

ABS SERIES

Race against time, healthier your life
www.saikangmedical.com



ABS Trolleys

Adopts aviation aluminum frame, light and beautiful
Adopt engineering ABS plastic
Modular design





DAISY SERIES

Race against time. healthier your life
healthsport.ch

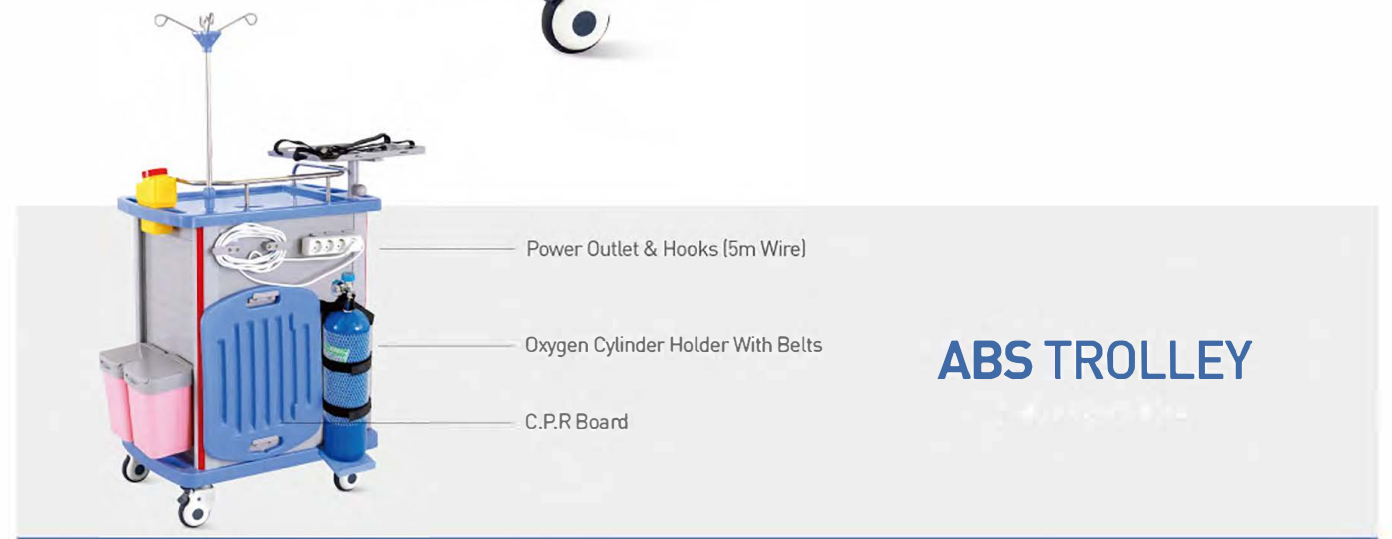
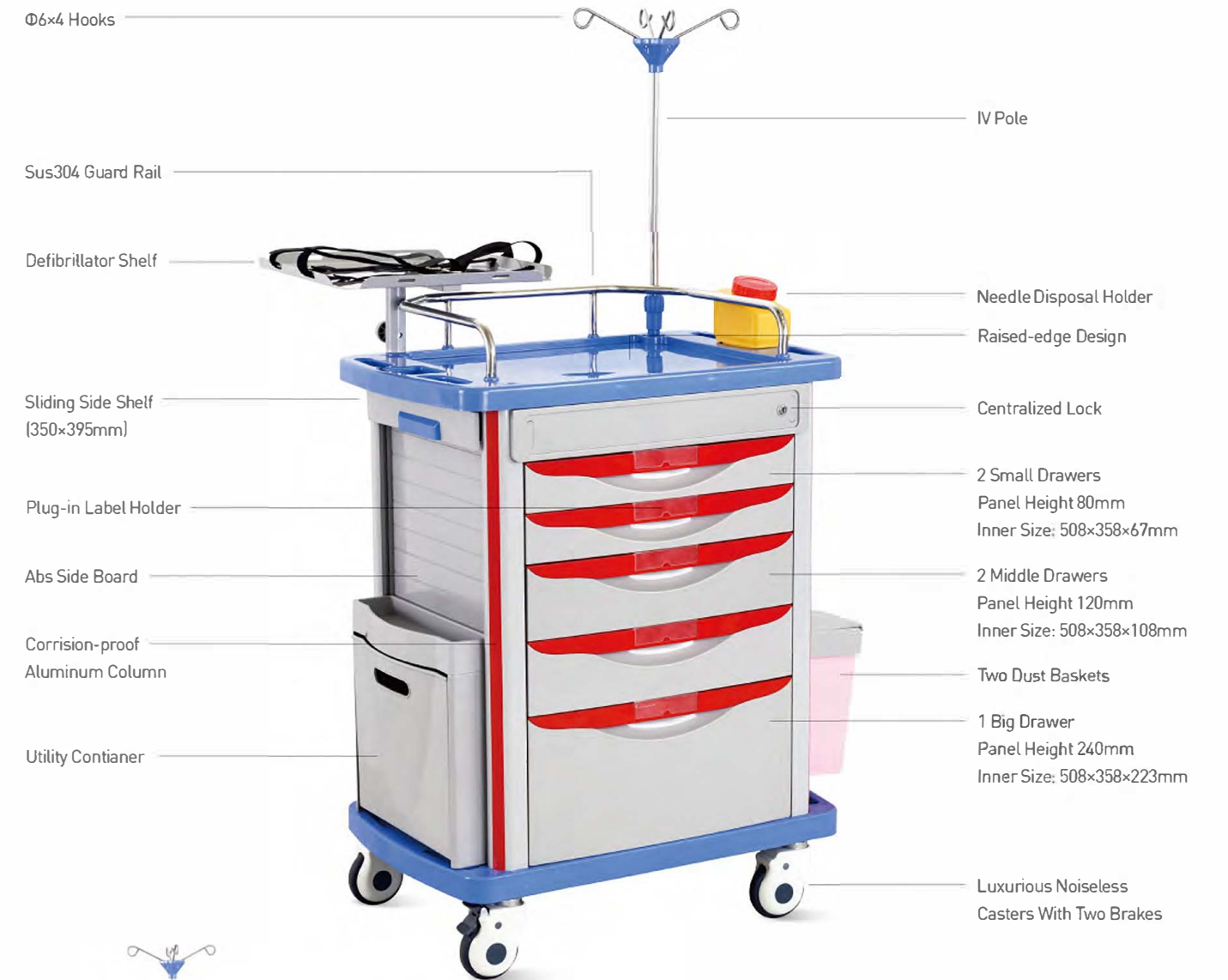

ABS TROLLEY



IV Pole
Φ6×4 Hooks



Sus304 Guard Rail



Centralized Lock
Big, Middle, Small Drawer



Corrosion-proof Aluminum Column



Needle Disposal Holder



Defibrillator Shelf
Sliding Side Shelf



Two Dust Baskets



Power Outlet & Hooks (5m Wire)



Luxurious Noiseless Casters
With Two Brakes



Utility Container



Oxygen Cylinder Holder With Belts
C.P.R Board

DAISY / SERIES

SKR054-ET
Emergency Trolley

850×520×960mm
750×475×930mm



SKR051-ET
Emergency Trolley

850×520×960mm
750×475×930mm



SKR051-AT
Anesthesia Trolley

850×520×960mm
750×475×930mm



SKR054-AT
Anesthesia Trolley

850×520×960mm
750×475×930mm



SKR054-AT
Anesthesia Trolley

850×520×960mm
750×475×930mm



SKR051-AT
Anesthesia Trolley

850×520×960mm
750×475×930mm



DAISY SERIES

Race against time, healthier your life
www.saikangmedical.com



DAISY / SERIES

SKR054-MT

Medicine Trolley

750×475×920mm



SKR054-MT01

Medicine Trolley

750×475×920mm

850×520×960mm



SKR054-AT01

Anesthesia Trolley

780×475×1000mm



SKR-CT750

Clinical Trolley

625×475×920mm



SKR-CT750-1

Clinical Trolleyt

625×475×920mm



SKR-IT750

Infusion Trolley

625×475×920mm



SKR-IT750-1

Infusion Trolley

625×475×920mm



JASMINE / SERIES

SKR-ET850

Emergency Trolley

850×520×990mm



Main Body

ABS Plastic And Steel-plastic, Easy To Clean.



Table Top | Guard Rail | Push Handle

All-in-one table top, ABS table top with transparent dust-proof pad, convex design to avoid dropping down



ABS plastic drawers sliding smoothly and silently.

3*3 drawer dividers for arbitrary partitioning.

5 drawers with centralized lock and plug-in labels to avoid dust. Different colors options for drawer holder.

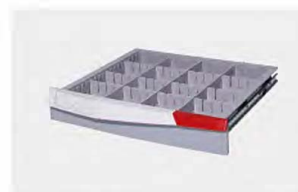

Two small drawers
panel height 80mm
inner size: 508×358×67mm

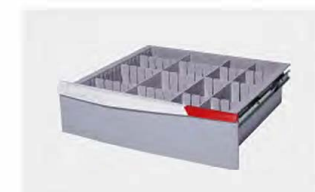

Two middle drawers
panel height 120mm
inner size: 508×358×108mm

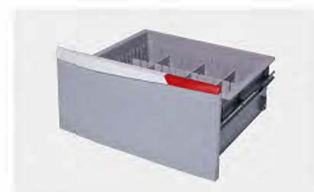

One big drawer
panel height 238mm
inner size: 508×358×223mm

SK-MT650

Drug Delivery Trolley

650×492×1000mm



SK-NT570

Mobile Nursing Trolley

570×550×980mm



SK-ET750

Emergency Trolley

750×530×1050mm



SK-MT750

Anesthesia Trolley

750×530×1050mm



ROSEMARY / SERIES

SKR-ET625
Emergency Trolley
625×475×930mm



SKR-MT625
Medicine Trolley
625×475×930mm



SKR-AT625
Anesthesia Trolley
625×475×930mm



SKR-CT625
Clinical Trolley
625×475×920mm



SKR-CT625-1
Clinical Trolley
625×475×920mm



SKR-IT625
Infusion Trolley
625×475×920mm



SKR-IT625-1
Infusion Trolley
625×475×920mm



VIOLET / SERIES

SKR-MT031
Medicine Trolley
750×475×930mm



SKR-AT031
Anesthesia Trolley
750×475×930mm



SKR-CT031
Clinical Trolley
750×475×920mm



SKR-CT031-1
Clinical Trolley
750×475×920mm



SKR-ET031
Emergency Trolley
750×475×930mm



SKR-IT031
Infusion Trolley
750×475×930mm



SKR-IT031-1
Infusion Trolley
750×475×920mm



LOTUS / SERIES

SKR024-WT

Mobile Nursing Workstation
520×510×1020mm



SKR-NT520

Mobile Nursing Workstation
520×510×950mm



SKR-CT600

Clinical Trolley
1100×470×1000mm



SKR-MT606

Clinical Trolley
1100×470×1100mm



SKR-ET223

Clinical Trolley
1100×470×1150mm



SKR-CT601

Clinical Trolley
1100×470×1150mm



VANILLA / SERIES

SKR022-8

Case History Trolley
450×410×895mm (30 Grids)



SKR022-5

Case History Trolley
450×410×895mm (25 Grids)



SKR022

Case History Trolley
450×410×895mm (25 Grids)



SKR021-5

Case History Trolley
750×410×895mm (50 Grids)



SKR021-6

Case History Trolley
750×410×895mm (50 Grids)



SKR021-9

Case History Trolley
750×410×895mm (60 Grids)



SKR-AB00

New All-in-One Computer Cart

490×780×980-1030mm

Optional:

portable plug-in high-performance lithium battery power supply system (with LED keyboard lights), provide uninterrupted power for equipment or computer, safe, reliable and convenient.

Casters:

Dual wheel casters for medical use, mute and smooth, the front two casters equipped with double pedal and total lock, 360 degree brake control, rear followed by two free casters.

Base:

ABS plastic shell, stability, easy to clean and maintain, high-strength metal structure base frame, strong load capacity and stability, the base integrated with foot pedal to control height adjustment.



SKR-A01

Simple All-in-One Computer Cart

650×490×1260mm

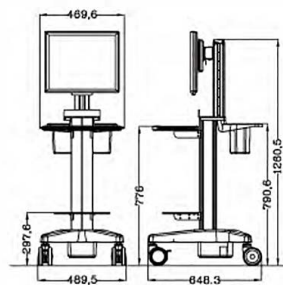

SKR-B00

Simple All-in-One Computer Cart

533×455×750-1150mm

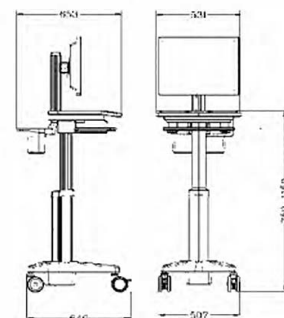

SKR-IB00

Simple Laptop Cart

533×455×750-1150mm



SKR-J10

Patient Monitor Cart

505×630×950mm



SKR-J21

Endoscopic System Equipment Cart

665×630×1650mm



SKR-R06

Monitor Cart

510×1000mm



SKR-R05

Tablet Cart

510×830mm



SKR-R03

Laptop Cart

530×520×850mm



SKR-R04

Ward Rounds Cart

530×520×730mm



SKR-R02

Mobile Multi-function Information Search Cart

530×520×1200mm



SKR-R01

Information Nursing Cart

520×620×1315mm



The hardware configuration of the above series of ward round systems: laptop, all-in-one computer, monitor, mini computer host + display, WiFi and other system solutions can be configured according to customer needs.

The hardware configuration of the above series of ward round systems: laptop, all-in-one computer, monitor, mini computer host + display, WiFi and other system solutions can be configured according to customer needs.

MORNING GLORY / SERIES

SKR004

Stainless Steel-ABS Trolley

730×480×900mm



SKR005

Stainless Steel-ABS Trolley

730×480×900mm



SKR006

Stainless Steel-ABS Trolley

730×480×900mm



SKR008

Stainless Steel-ABS Trolley

730×480×900mm



IVY / SERIES

SKR001

ABS Utility Trolley

539×366×845mm
640×456×845mm
760×520×845mm



SKR001-3

ABS Utility Trolley

539×366×910mm



SKR001-4

ABS Utility Trolley

640×456×845mm
760×520×845mm



SKR002-1

ABS Utility Trolley

539×366×855mm
640×456×855mm
760×520×855mm



SKR002-3

ABS Utility Trolley

539×366×855mm



SKR002-4

ABS Utility Trolley

640×456×855mm
760×520×855mm





COLOR PAINTED STAINLESS STEEL SERIES

Leading Branding of China Medical Furniture
www.saikangmedical.com



COLOR

Colorful Humanized Design

Adopting the influence of color on people's emotions, breaking the traditional color feeling of medical space and medical supplies.

Create a healing color combination that enhances vitality and aims for health.

To improve the patient's healing comfort, relieve the pressure of medical staff, and inject warmth into the medical space.



RHOMBUS / SERIES

SKR801

Movable Nurse Care Station (All in one)

Wireless Electronic Chemical Solutions

- High performance and high security battery system
- AC and DC power supply automatic conversion function
- Large capacity and low weight battery design reduces the work intensity of nursing staff
- LCD screen timely power display and alarm, one-touch switch
- One-piece machine-specific bracket, can be connected, install the market mainstream brand any model one machine, or a full set of hospital-type one machine to achieve wireless electronic work
- All-in-one bracket has lift mounting, rotation and tilt function
- Telescopic built-in cable management

Nursing Function Solution

- 8-10 beds daily infusion storage space
- Dozens of varieties, specifications of various types of sterile items, aseptic supplies, medicines, care appliances, classification
- Hand disinfectant, sharp sharp box, glove box, etc
- Various types of medical waste, domestic garbage sorting and recycling



B
Size: 650×470×930mm

A
Size: 660×500×950mm



Battery System

High performance and high security battery system
AC and DC power supply automatic conversion function
Large capacity and low weight battery design reduces the work intensity of nursing staff



One-piece Machine-specific Bracket

Can be connected, install the market mainstream brand any model one machine, or a full set of hospital-type one machine to achieve wireless electronic work
All-in-one bracket has lift mounting, rotation and tilt function



Drawer

Large, medium and small drawers are optional
Wide stainless steel handle for improved grip comfort
Ultra-quiet track is smooth



Telescopic Cable

Telescopic, built-in cable management



LCD Screen Timely Power

Display and alarm, one-touch switch



Dust Bin

Flip cover automatically closed
Lightweight and beautiful, flexible assembly and disassembly



Sharp Container

Freely adjustable
Size can be choose



Metal Cover

Independent, large capacity

Ø6*4 Hooks

S.S.I.V Pole

Sharp Container

High Strength Aluminum Alloy

Dust Bin

5 Inch Covered Castors All With Brakes

Color Painted Nursing Trolley

304 S.S Guard Rail

High Quality Epoxy Coated Top

Aluminium Alloy Handle

2 Small Drawer
Inner Size: 494×360×75mm

S.S Debris Basket

2 Medium Drawer
Inner Size: 494×360×105mm

1 Big Drawer
Inner Size: 494×360×200mm

Bumper



Concealed Side Pull Drawer

Silent and smooth rails, replaceable sub-workbench



Lateral Drawer Lock

Hidden on the side, avoiding the key blocking the first drawer from closing, avoiding the key colliding with it



Adjustable Medicine Division

The size of the drug can be adjusted according to the size of the drug placed

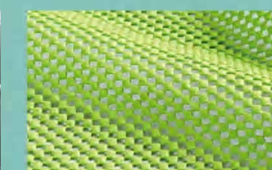

Grid Crash Pad

Soft material to avoid drug and drawer bump



Cpr Rescue Board

Easy to access, easy to use

COLOR PAINTED NURSING TROLLEY

SKR-MT670-1

Color Painted
Multifunctional
Nursing Trolley
670×450×880-960mm



SKR-MT670

Color Painted
Multifunctional
Nursing Trolley
670×450×880-960mm



SKR-MT670-2

Color Painted
Multifunctional
Nursing Trolley
670×450×880-960mm



SKR-MT670-3

Color Painted
Multifunctional
Nursing Trolley
670×450×880-960mm



SKR-NT670

Color Painted
Multifunctional
Nursing Trolley
670×450×880-960mm



SKR-NT670-1

Color Painted
Multifunctional
Nursing Trolley
670×450×880-960mm



SKR-CT670-1

Color Painted
Multifunctional
Nursing Trolley
670×450×920-950mm



SKR670-2

Color Painted
Multifunctional
Nursing Trolley
670×450×920-950mm



SKR670-3

Color Painted
Multifunctional
Nursing Trolley
670×450×920-950mm



SKR-AT670-1

Color Painted
Multifunctional
Nursing Trolley
670×450×970-1500mm



SKR670

Color Painted
Multifunctional
Nursing Trolley
670×450×940mm



SKR670-1

Color Painted
Multifunctional
Nursing Trolley
670×450×940mm



COLOR PAINTED NURSING TROLLEY

SKR-CT670-4

Color Painted Treatment Trolley

670×450×880-960mm



SKR-CT640-5

Color Painted Treatment Trolley

670×450×880-960mm



SKR050

Color Painted Multifunctional Trolley

620×420×900mm



SKR062

Color Painted Multifunctional Trolley

710×450×860mm



SKR-CT670-3

Color Painted Treatment Trolley

670×450×880-960mm



SKR-CT670

Color Painted Treatment Trolley

670×450×825-1000mm



SKR-CT670-2

Color Painted Treatment Trolley

670×450×880-960mm



SKR-AT610

Color Painted Anaesthesia

610×410×970mm



SKR060

Color Painted Multifunctional Trolley

1070×410×925mm



SKR-CT710

Luxury Treatment Trolley

710×450×880mm



SKR024-1

Color Painted Case History Folder Trolley

700×410×900mm (40 Grids)
700×410×1000mm (50 Grids)



SKR024

Color Painted Case History Folder Trolley

385×410×960mm (20 Grids)



SKH013

Stainless Steel Case History Trolley

630×430×900mm (40 Grids)



SKH014

Stainless Steel Case History Trolley

340×400×900mm (20 Grids)



SKR023

Chart Holder

230×320mm
230×355mm
320×320mm



SKE020-1

Step Stool

405×230/170×340mm



SKE020-4D

Step Stool

405×230×220mm



SKE020-10

Step Stool

400×300×90mm



SKE020-8

Step Stool

496×342×500-120mm
496×342×600-159mm
496×342×750-200mm



SKE017-3

Surgery Stool

Φ 350×460-600mm
(Backrest 300mm)



SKE017-2

Surgery Stool

Φ 290×470-670mm



SKE020-15

Step Stool

460×250×80mm
460×250×120mm
460×250×165mm



SKH006C

Instrument Trolley

670×450×900mm



SKH003-2

Instrument Trolley

460×460×860mm



SKH001

Treatment Trolley

670×450×900mm



SKH002

Dressing Trolley

670×450×900mm



SKH006-5

Treatment Trolley

460×460×860



SKH004

Instrument Trolley

670×450×900mm



SKH005

Fan-shaped Instrument Trolley

1550×460×900mm



SKH007-1

Instrument Trolley

1000×500×900mm



SKH002T

Dressing Trolley

670×450×900mm



SKH029

Dressing Trolley

670×450×900mm



SKH030

Treatment Trolley

650×450×930mm



SKH038-1

Mayo Trolley

600×400×870-1200mm



SKH038-2

Mayo Trolley

500×350×870-1300mm



SKH022

Treatment Trolley

600×400×850mm



SKH032
Infusion Trolley
670×450×900-1700mm



SKH028
Dressing Trolley
670×450×1000mm



SKH006-1
Treatment Trolley
670×450×900mm



SKH004-1
Treatment Trolley
670×450×900mm



SKH006-2
Treatment Trolley
670×450×900mm



SKH006-102
Treatment Trolley
670×450×1000mm



SKH021
Emergency Trolley
600×400×850mm



SKH018
Anesthesia Trolley
600×400×850mm



SKH020
Emergency Trolley
600×400×850mm



SKH019
Emergency Trolley
600×400×850mm



SKH012
Insulated Food Cart
1030×550×980mm



SK027-1

Dressing Trolley

Fold Size: 655×555×940mm
Unfold Size: 1110×555×940mm



SKH027

Stainless Steel Morning Care Trolley

900×450×1050mm



SKH034-5

Stainless Steel Movable Waste Bucket

Φ400mm×Φ300mm×165mm×14L



SKR041(5)

Stainless Steel Waste Basin

Φ520mm×810-1300mm



SKH040-1

Waste Collecting Trolley

800×600×840mm



One Bag, Four Bags



SKH027-2

Waste Collecting Trolley

800×590×890mm



SKR-WC561

Waste Collecting Trolley

800×590×890mm



SKH040(1)

Stainless Steel Laundry Trolley

800×600×840mm



SKH040(2)

Stainless Steel Laundry Trolley

Φ600×840mm



SKH041(6)

Stainless Steel Waste Basin

Φ520mm×810-1300mm



Department Of Surgery (Medical Auxiliary Room)



- 1 Flat Opening Shelf
- 2 Manual Washing Sink
- 3 Toilet Waste Pool
- 4 Waste Collecting Table For Transferring
- 5 Single Washing Unit
- 6 Double Waste Trolley
- 7 Waste Trolley
- 8 Shoes Shelf
- 9 Mop Holder
- 10 Mop Pool

Central Supply Room

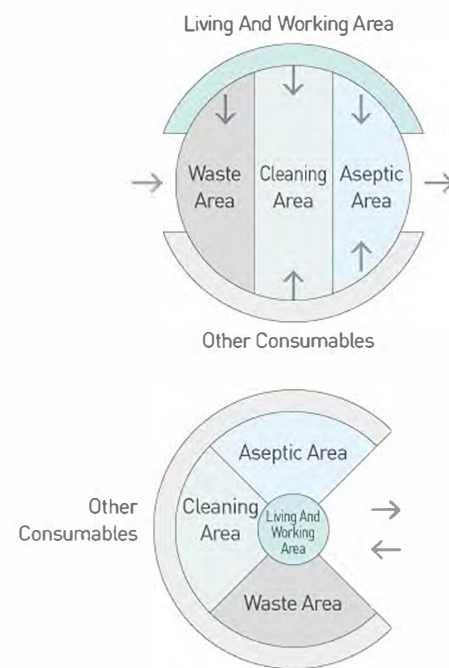
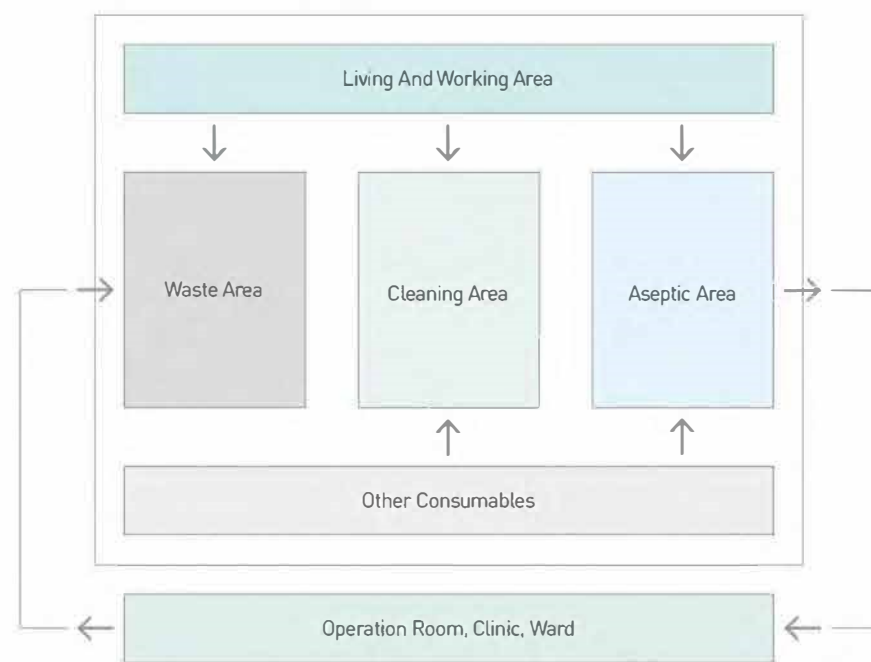

SKH036

Stainless Steel Washing Sink



One Tap: 600×600×1100mm

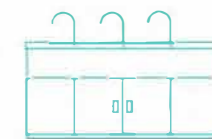

Three Taps: 1800×600×1100mm

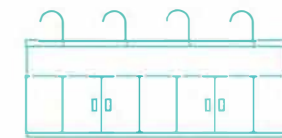

Four Taps: 2400×600×1100mm



Two Taps: 1200×600×1100mm



Control Ways Of Dispensing

Inductive pumping dispensing
Inductive hanging dispensing



Control Ways Of Water Temperature

International brand hot water system
Practical type hot water system
Hot water thermostat

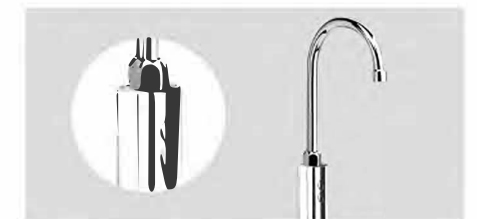

Faucet
Shower
Control ways of watering

Optional Accessories



Mirror



Durable brush



Water Filter system



Stainless steel brush system

SKH068

Stainless Steel Cabinet
900×400×1800mm



SKH052

Stainless Steel Cabinet
900×400×1800mm



SKH054

Stainless Steel Cabinet
900×500/280×1800mm



SKH055

Stainless Steel Cabinet
1800×500/280×1800mm



SKH070

Work Table
1800×700×800mm
1200×600×800mm



SKH071

Work Table
1800×700×800mm
1200×600×800mm



SKH071-1

Work Table
1800×700×800mm
1200×600×800mm



SKH051A

Powder Coated
900×400×1800mm



SKH052A

Powder Coated
900×400×1800mm



SKH058-5A

Powder Coated
900×400×1800mm



SKH057A

Powder Coated
900×400×1800mm



SKH077

Work Table
1200×800/300×1600mm



SKH060

Rotary Medicine Shelf
Φ920×1780mm



SKH062

Two-sided Adjustable
Medicine Shelf
800×860×2000mm



SKH122-2

Delivery Trolley

650×420×1500mm

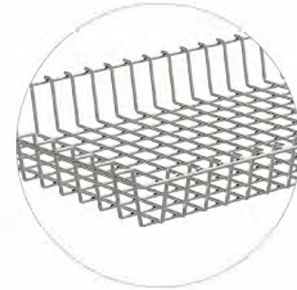

SKH078-1

Storage Rack

1200×600×1800mm



SKH078

Storage Rack

1200×600×1860mm



SKH088

Swab Stand

900×500×1500mm



SKH039

Stainless Steel Trolley

750×500×950mm



SKH039-2

Stainless Steel Trolley

750×500×950mm



SKH008

Stainless Steel Trolley

800×480×760mm



SKH008-2

Stainless Steel Trolley

800×480×760mm



SKH010-1

Stainless Steel Trolley

900×550×900mm





Phenolic Resin Board



Structural Representation

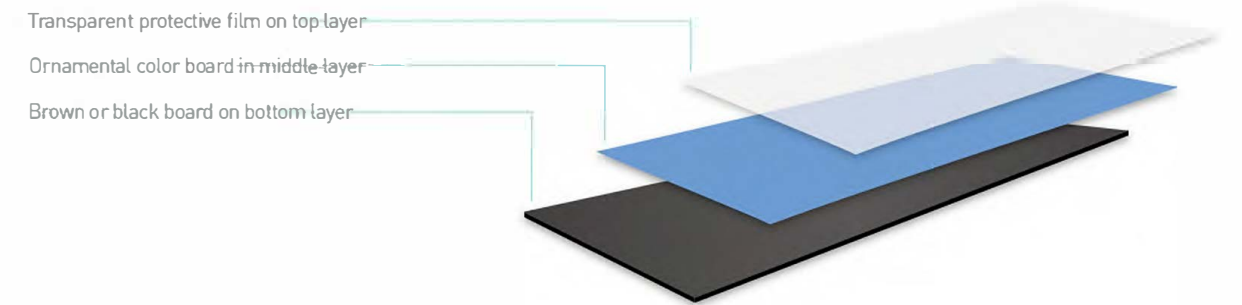

Thickness Optional

Standard Thickness mm	Standard Thickness mm	Standard Thickness Mm	Standard Thickness mm	Standard Thickness mm	Standard Thickness mm	Standard Thickness mm
4	6	8	10	12	13	16

Advantages

 Space-saving	 Colorful	 Impact Resistance	 Fire-proof	 Water-proof	 Chemical Resistance
------------------	--------------	-----------------------	----------------	-----------------	-------------------------

PHENOLIC SERIES

Leading Branding of China Medical Furniture
www.saikangmedical.com

GALAXY / SERIES

SKR-ET600
Emergency Trolley
600×480×980mm



SKR-MT610
Drug Delivery Trolley
610×480×891 mm



SKR-ET601
Emergency Trolley
600×480×980mm



SKR-IT680
Infusion Trolley
680×480×891-1520mm



SKR-IT680-1
Infusion Trolley
680×480×891-1520mm



SKR-NT680
Infusion Trolley
680×480×891-1520mm



SKR-AT674
Anesthesia Trolley
674×480×920-1520mm



SKR-AT674-1
Anesthesia Trolley
674×480×920-1520mm



SKR-AT674-2
Anesthesia Trolley
674×480×920-1520mm



GALAXY / SERIES

SKR-T01
Fan-shaped
Instrument Trolley
1438×580×891mm



SKR-MT1200
Drug Delivery Trolley
1200×480×891mm



SKR-MT1200-1
Drug Delivery Trolley
1200×480×1210mm



SKR-T02
Double Deck Worktable
1000×600×891mm



SKR-CT600
Clinical Trolley
600×480×980mm



SKR-CT650
Clinical Trolley
650×480×891mm



SKR-CT650
Clinical Trolley
650×480×891mm



SKR372
Case History Trolley
372×400×83mm



SKR686-1
Case History Trolley
686×400×1114mm



SKR686
Case History Trolley
686×400×838mm



ACCESSORIES

Leading Branding of China Medical Furniture
www.saikangmedical.com



P001-Centralized Lock



P002-Password Lock



P003-Disposable Lock



P004-IV Pole With 2 Hooks



P005-IV Pole With 4 Hooks



P006-Double-side Caster



P007-Directional Castor



P008-Universal Covered Castor



P009-Single-side Castor



P010-Sharp Container



P011-Sharp Container



P012-Waste Bucket



P013-Two Waste Bucket



P014-Mini Dust Bin



P015-Flip Trash Can



P016-Double Trash Can With Rotating Lid



P017-Middle Size Waste Bucket



P018-Trash Can



P019-Trash Can



P020-Large Storage Box



P021-Plastic Medicine Tray



P022-ABS Drawer



P023-ABS Drawer



P024-48 Grids Medicine Tray



P025-Four-color Medicine Tray



P026-Medicine Tray



P027-Side Box



P028-Stainless Steel Utility Basket

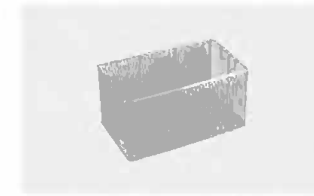

P029-Stainless Steel Classification Basket

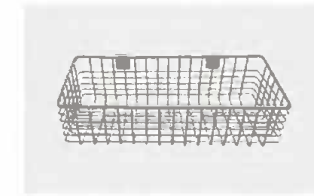

P030-Basket

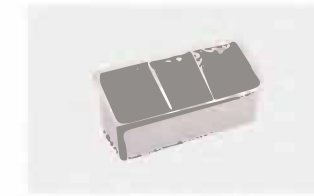

P031-Narrow Medicine Tray

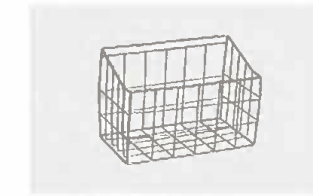

P032-File Basket

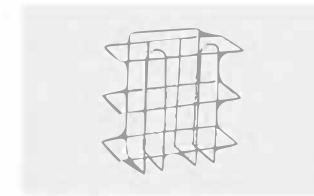

P033-File Basket



P034-Utility Container

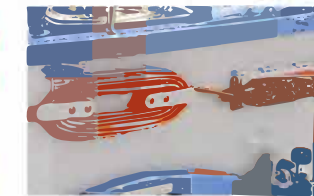

P035-Power Outlet & Hooks

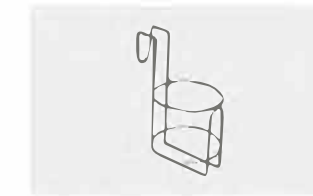

P036-Hand Soap Holder



P037-Label Box

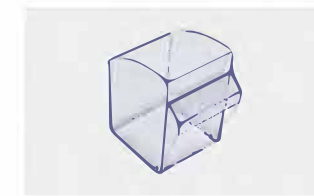

P038-Anesthesia Box



P039-Oxygen Cylinder Holder



P040-Cpr Board

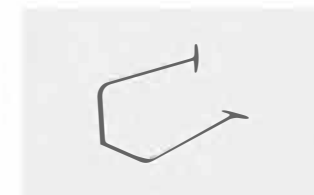

P041-Scissors Holder



P042-Gloves Holder



P043-Adjustable Medicine Tray

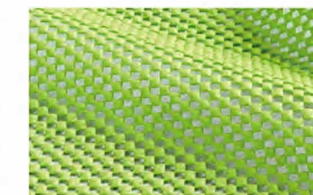

P044-Grid Crash Pad

MODULAR STRUCTURE

- Adjustable length
- Expandable and upgradeable
- Hygienic surfaces, the surface adopt electrostatic powder coating with static dust,
- Flexible positioning of gas terminal units and electronic connections
- Variety of integrated light options to choose from
- Many model for your choose
- Front panels can be opened, easy to maintenance work
- Security, inside of panel, the unit is divided into several passages by an aluminum barrier.
- extruded aluminum profiles. The length can be freely configured up to a maximum of 6 m.
- For Intensive Care Units, Recovery Rooms and Wards

Model 1: BH-MEX005



Model 2: BH-CTR001

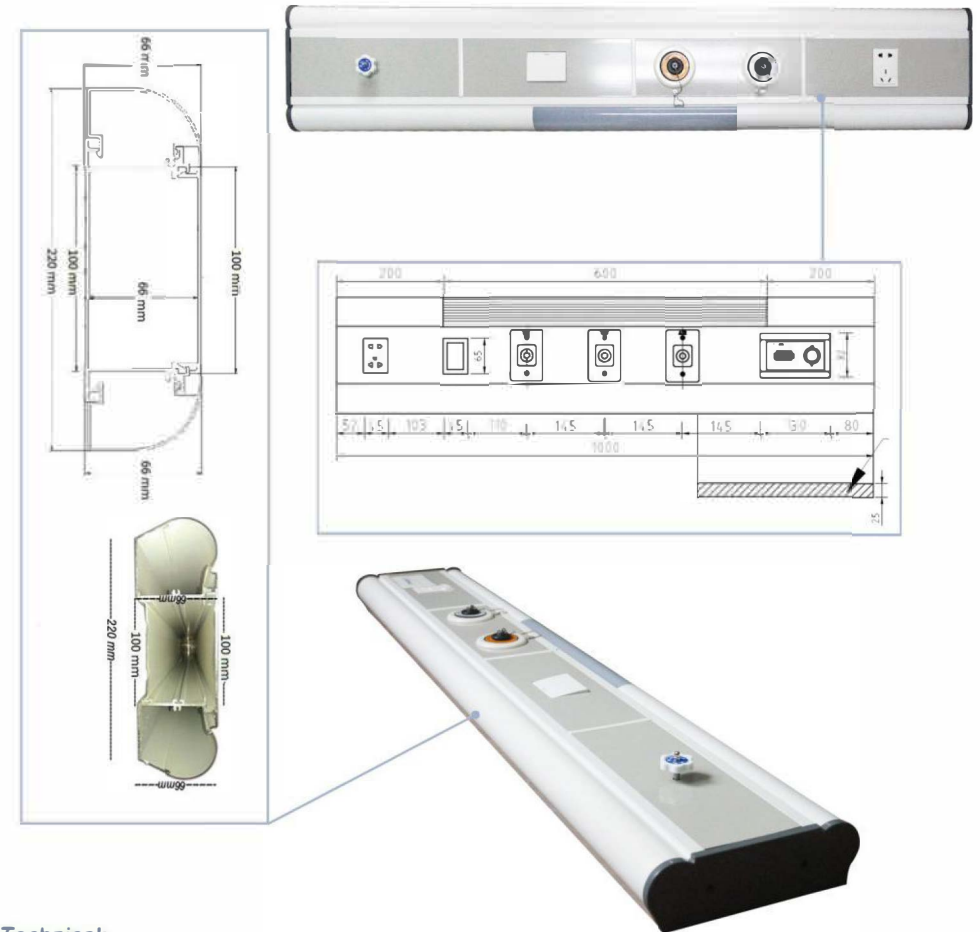

Technical:

Material: aluminum alloy

Dimension: 183(W) mm x 66(D) mm, length defined by customer

Middle panel width is 100mm

Standard color: both side is white, middle is gray

Light: top and down can install light, for your choose

Medical rail is optional

Bed Head Unit

Model 3: BH-GTR001

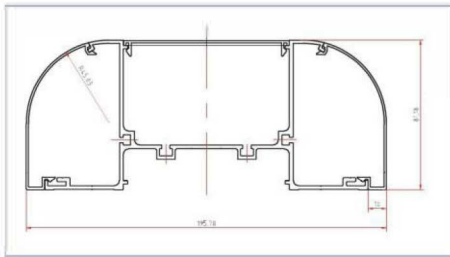

Technical:

Material: aluminum alloy

Dimension: 195(W) mm x81(D) mm, length defined by customer

Middle panel width is 100mm

Standard color: white color

Light: top and down can install light, for your choose

Bed Head Unit

Model 4: BH-GTE001

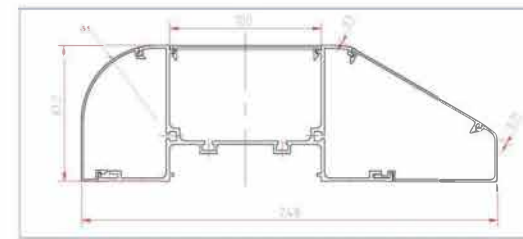
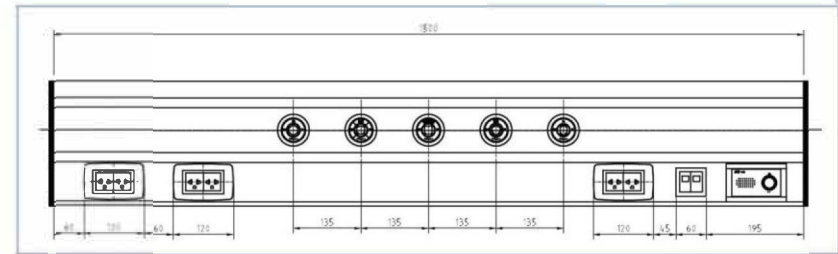

Technical:

Material: aluminum alloy

Dimension: 248(W) mm x81(D) mm, length defined by customer

Middle panel width is 100mm

Standard color: white color

Light: top and down can install light, for your choose

Medical rail is optional

Bed Head Unit

Model 5: BH-GTR002

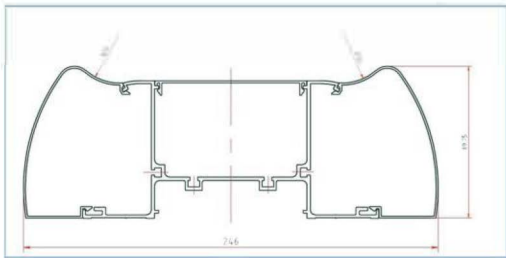
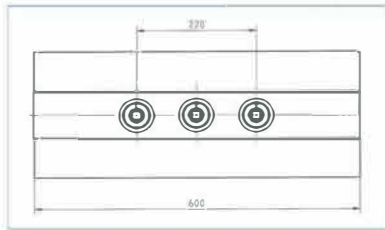

Technical:

Material: aluminum alloy

Dimension: 246(W) mm x89(D) mm, length defined by customer

Middle panel width is 90mm

Standard color: white color, yellow color is optional No light

Bed Head Unit

Model 6: BH-GTE003

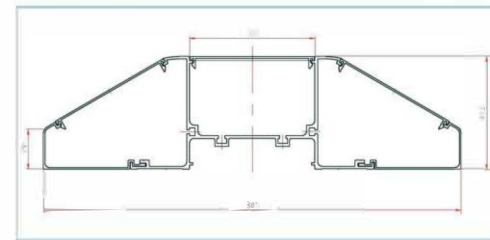
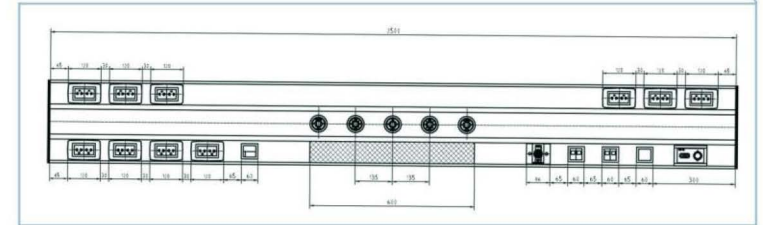

Technical:

Material: aluminum alloy

Dimension: 301(W) mm x81(D) mm, length defined by customer

Middle panel width is 100mm

Standard color: white color

Light: top and down can install light, for your choose

Medical rail is optional

Bed Head Unit

Model 7: BH-MEX003

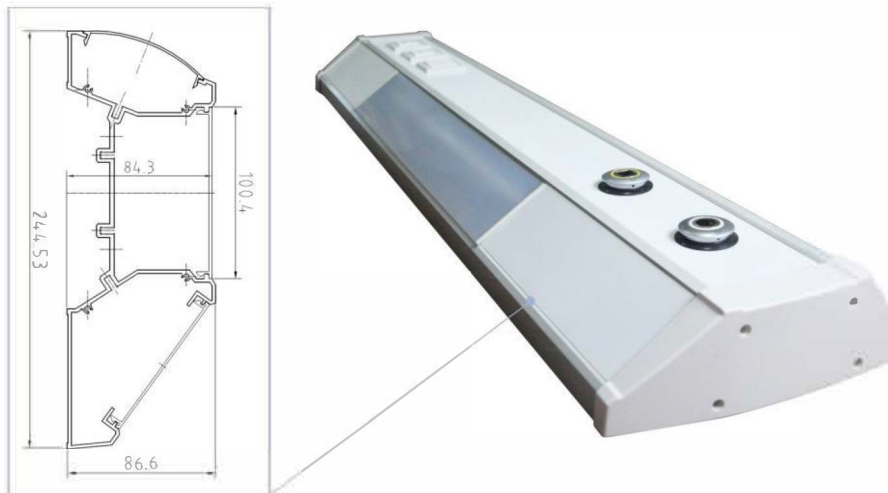

Technical:

Material: aluminum alloy

Dimension: 244(W) mm x86(D) mm, length defined by customer

Middle panel width is 100mm

Standard color: white color, Middle is gray or white is optional

Light: down can install light Medical rail is optional

Monitor Bracket is optional

Bed Head Unit

Model 8: BH-MEX001



Technical:

Material: aluminum alloy

Dimension: 176.5(W) mm126.3(D) mm, length defined by customer

Standard color: white color, yellow is optional

Light: down can install light

Bed Head Unit

Model 9: BH-MEX002

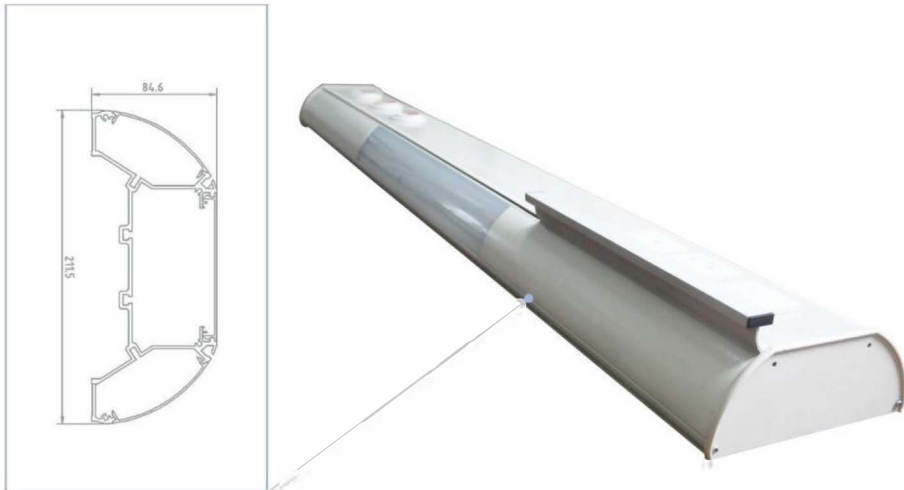

Technical:

Material: aluminum alloy

Dimension: 211.5(W) mm x 84.6(D) mm, length defined by customer

Middle panel width is 100mm

Standard color: both side is white, middle is gray

Light: top and down can install light, for your choose

Medical rail is optional

Bed Head Unit

Model 10: BH-AWB001



- Technical:**
- 1、 Push-pull murals can meet the health care functions, and achieve the overall room design at the same time.
 - 2、 The health care equipment at interior, covert design, effectively block dust and man-made pollution.
 - 3、 External mural design, with the overall design of furniture to create comfortable atmosphere for recovery.
 - 4、 Separation of gas and electricity, safe and reliable.
 - 5、 Profuse medical products and accessories, clients can customize

Medicine Cabinet



Medicine Cabinet SKH067
Size: 380*450*1800mm



Medicine Cabinet SKH081-1
Size: 380*450*1800mm



Medicine Cabinet SKH053
Size: 900*400*1800mm



Four-door Wardrobe SKH058-5
Size: 900*450*1800mm



Four-door Wardrobe SKH058
Size: 900*450*1800mm



Six-gateway Cabinet SKH056
Size: 900*450*1800mm

Eighteenth-gateway Shoe Cabinet SKH057-1
Size: 900*400*1800mm



Eighteenth-gateway Shoe Cabinet SKH057
Size: 900*400*1800mm



Instrument Cabinet SKH050
Size: 900*400*1800mm



Instrument Cabinet SKH051
Size: 900*400*1800mm



Instrument Cabinet SKH052
Size: 900*400*1800mm



Medicine Cabinet SKH054
Size: 900*500/300*1800mm



Single-sided Storeroom Medicine Shelf SKH059
Size: 800*460*2000mm

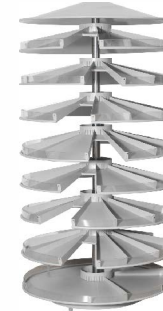

Rotary Medicine Shelf SKH060
Size: φ920*1800mm



Adjustable Component Medicine Shelf SKH061
Size: 1030*500*2000mm



Two-sided Adjustable Medicine Tray SKH062
Size: 800*800*2000mm



HFS

A VOTRE SERVICE DEPUIS 1995

HFS Group
Route de Taillepied 44
1095 Lutry
direction@healthsport.ch
healthsport.ch
+41 21 803 57 67