



A VOTRE SERVICE DEPUIS 1995

2026



## EXPERIENCE

Over 20 years of market experience.

We operate in 57 countries.

Successful co-operation with numerous customers around the world.

## ERFAHRUNG

Über 20 Jahre Markterfahrung.

Unsere Produkte machen Spaß in 52 Ländern.

Erfolgreiche Zusammenarbeit mit vielen Kunden aus der ganzen Welt.

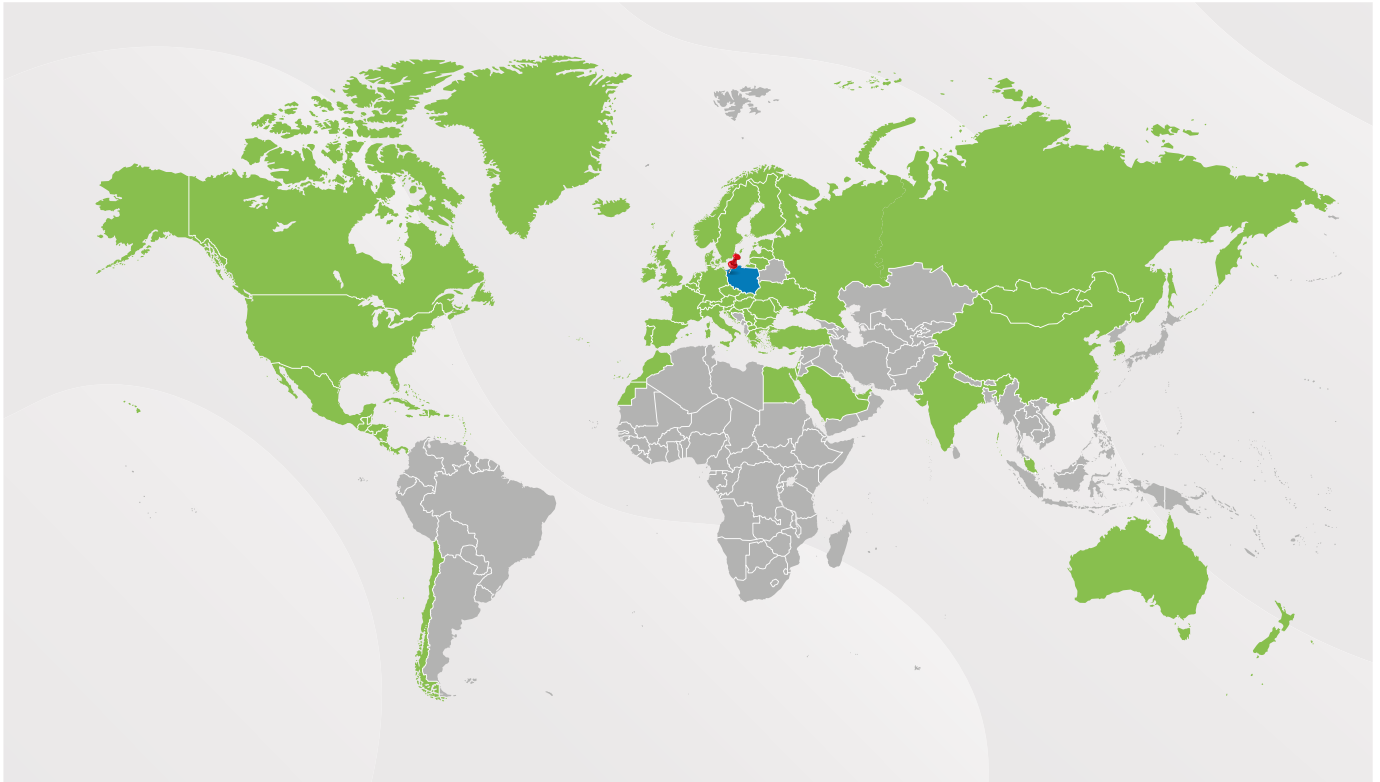

## OFFER | ANGEBOT



SFERO  
LIMAKO  
LUMO PLAY  
SALTO  
INTEGRADO  
LINARIUM  
TRANSPORTO  
MONTA  
ROTO  
PARK  
AKRA  
ROBINIA  
DOG AGILITY



SPEED  
FITNESS  
STREET WORKOUT  
NINJA PARK  
ARENAS  
OUTDOOR GAMES



COLLECTIONS  
BENCHES  
TRASH BINS  
BICYCLE RACKS

**Order our catalogue:**



direction@healthsport.ch  
sales@healthsport.ch

**Sie können den Katalog in Papierform bestellen:**

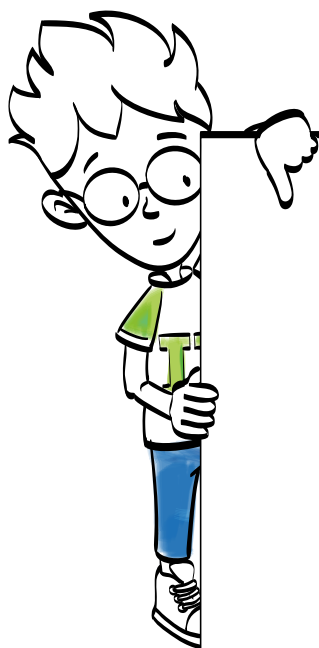
direction@healthsport.ch  
sales@healthsport.ch



**Please contact us:**

-  direction@healthsport.ch
-  +41 21 903 57 67
-  <https://healthsport.ch/>

**Zögern Sie sich nicht,  
uns zu kontaktieren:**

-  direction@healthsport.ch
-  +41 21 903 57 67
-  <https://healthsport.ch>

# Inter Play Studio

Free online application to design your playground in minutes. Draw or set the size of your plot, drag-and-drop equipment, and preview the layout in 2D or 3D with automatic safety clearances.

Kostenlose Online-Anwendung, um Ihren Spielplatz in wenigen Minuten zu planen. Zeichnen oder definieren Sie die Größe Ihres Grundstücks, platzieren Sie Geräte per Drag-and-drop und sehen Sie die Anordnung in 2D oder 3D – mit automatischen Sicherheitsabständen.

1



**Drag-and-drop equipment** from our catalogue; filter by function, series, age group, landscape, or surface.

**Drag-and-drop oder Belag.** von Geräten aus unserem Katalog; Filter nach Funktion, Serie, Altersgruppe, Landschaft

2



**Automatic safety zones** generated from product specs to help meet standards.

**Automatische Sicherheitsbereiche** gemäß Produktspezifikationen – zur normgerechten Planung.

3



**Save & share** visuals for internal approvals and stakeholder presentations.

**Speichern & teilen** von Visualisierungen für interne Freigaben und Stakeholder-Präsentationen.

Prototype early. Test ideas before detailed design begins.

Früh prototypen. Ideen testen, bevor die Detailplanung startet.

Reduce rework. Safety clearances and space rules are visible from the start.

Nacharbeit reduzieren. Sicherheitsabstände und Flächenregeln sind von Anfang an sichtbar.



Choose smarter. Compare options, swap items, and refine the layout on the fly.

Klüger auswählen. Varianten vergleichen, Geräte tauschen und das Layout spontan verfeinern.



Try this tool on **interplay.eu**

Probieren Sie dieses Werkzeug aus **interplay-spiel.de**





„Now with AI image creation support“

„Jetzt mit Unterstützung von KI-Bilderstellung“

# TRAMPOLINE DESIGN STUDIO

**Create your unique design on the trampoline.**  
Based on your project, we will make a trampoline for you.

**Erstellen Sie Ihr einzigartiges Design für das Trampolin.** Basierend auf Ihrem Projekt werden wir ein Trampolin für Sie anfertigen.

1



Choose trampoline parameters (shape, size, collar color)

Wählen Sie die Trampolinparameter (Form, Größe, Farbe des Kragens)

2



Create a unique, custom trampoline design.

Erstellen Sie ein einzigartiges, individuelles Trampolin-Design.

3



Receive your design at the provided email address. You can order the trampoline production from us.

Erhalten Sie Ihr Design an die angegebene E-Mail-Adresse. Sie können bei uns die Herstellung des Trampolins bestellen.

Possibility to save the project file and return to work on it later.

Möglichkeit, die Projektdatei zu speichern und später weiter daran zu arbeiten.

Choose from various sizes and shapes of trampolines.

Wählen Sie aus verschiedenen Größen und Formen von Trampolinen.

The design of the trampoline is limited only by your imagination.

Das Trampolinmuster ist nur durch Ihre Vorstellungskraft begrenzt.

Wide selection of trampoline lamellas and collar colors.

Große Auswahl an Farben für Lamellen und Trampolinrand.

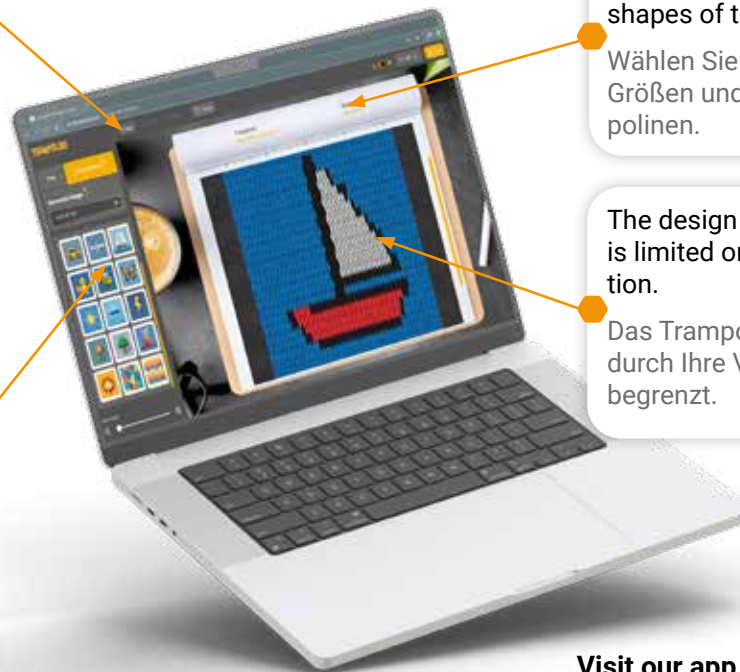

Visit our app

Besuchen Sie unsere App



[tdesign-studio.com](https://tdesign-studio.com)



LUMO  
PLAY

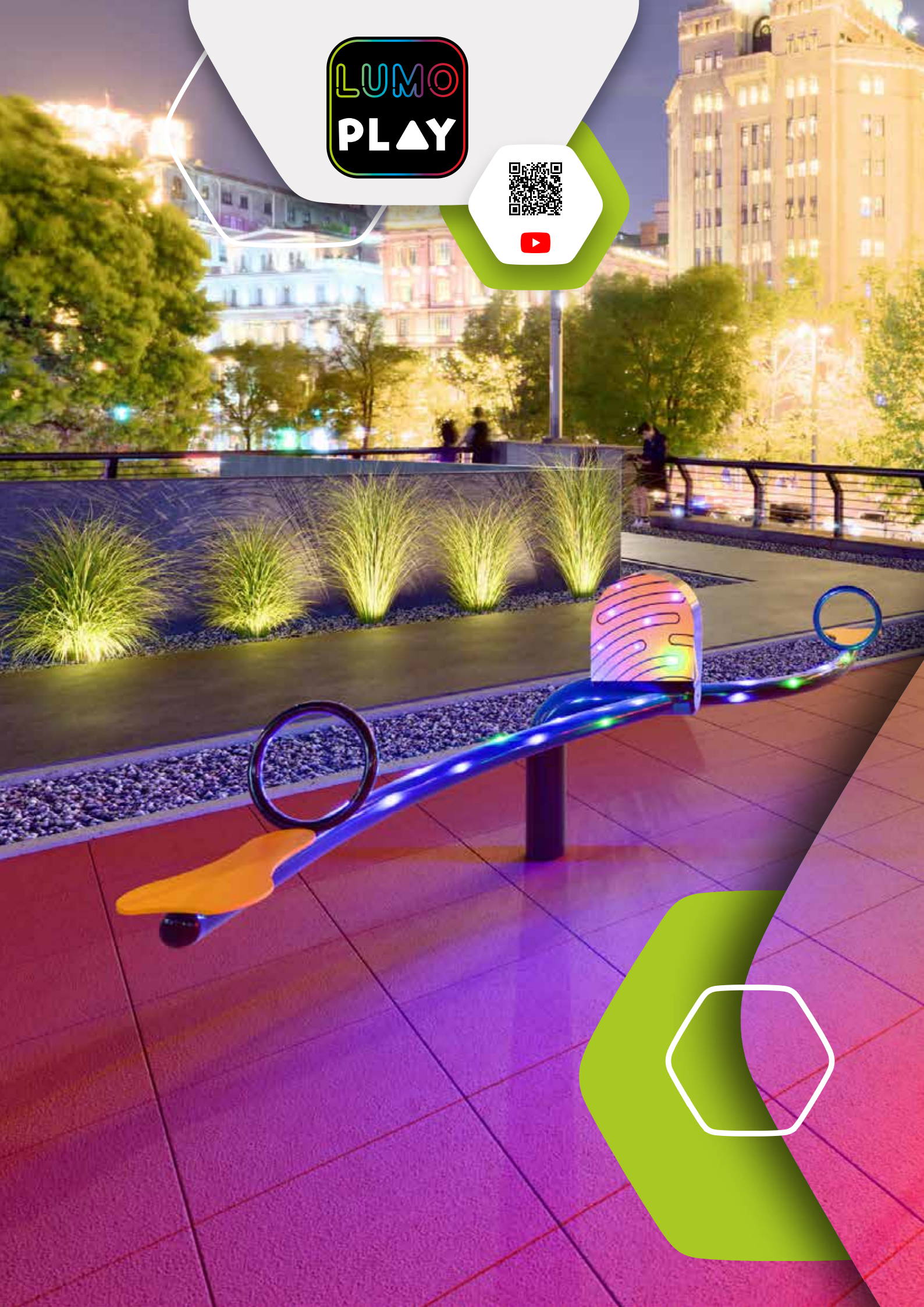





# LIGHT & SOUND

**LUMO PLAY is an unique light and sound system - it generates light and sound while device is in motion, thanks to which the product is colourfully illuminated and at the same time plays funny melodies. It takes the playground to higher level, making it interactive, modern and attractive for children of all ages.**

**LUMO PLAY ist ein einzigartiges Licht- und Soundsystem - es erzeugt Licht und Ton, wenn das Spielplatzgerät bewegt wird, so dass das Produkt farbig leuchtet und gleichzeitig lustige Melodien spielt. LUMO PLAY bringt den Spielplatz auf ein höheres Niveau und macht ihn interaktiv, modern und attraktiv für Kinder jeden Alters.**

## Light

When the roundabout is put in motion it illuminates colourfully with Fibre optic lights.

## Licht

Wenn Sie das Spielzeug in Bewegung setzen, blinkt das Spielzeug mit farbigen Fibre optic-Leuchten.

## Music

When device is in motion music starts to play. Built-in speaker provides high quality sound.

## Musik

Wenn Sie das Spielzeug in Bewegung setzen, werden Sie Musik hören. Die eingebauten Lautsprecher sorgen für die richtige Klangqualität.



## App

Control it by mobile phone downloading LUMO PLAY App from Google Play or App Store.

## App

Laden Sie die LUMO PLAY App von Google Play oder App Store herunter und steuern Sie Musik und Licht.



## Play your favourite music

Connect it to Spotify, YouTube or Tidal and play your favourite tunes and songs while using it.

## Spielen Sie Ihre Lieblingsmusik ab

Verbinden Sie sich mit Spotify, YouTube oder Tidal und spielen Sie Ihre Lieblingslieder ab.



## Administrator

The app allows to override music and light settings. Depends on the time of day, modify the volume or ON/OFF settings.

## Administrator

Die App ermöglicht übergeordnete Musik-, und Lichteinstellungen. Ändern Sie die Lautstärke- oder ON/OFF-Einstellungen je nach Tageszeit



## Power

Power is generated by movement, so external power supply or battery is not required

## Strom

Der Strom wird während der Bewegung des Spielzeugs erzeugt. Daher benötigen die Spielplatzgeräte mit dem LUMO PLAY System weder eine Batterie noch einen externen Anschluss



LUMO PLAY APP



1



2



3



4





**NORTE 130 LUMO PLAY**  
GK-RO-201-LP-H

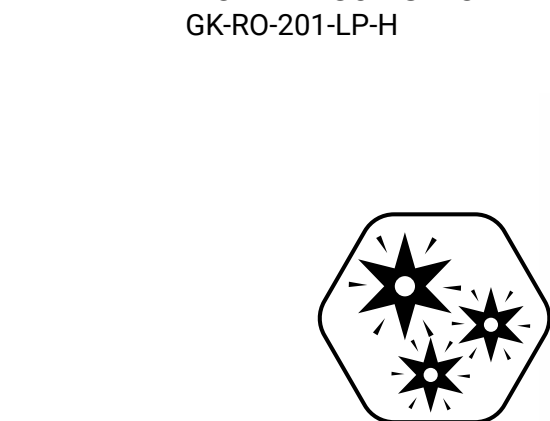
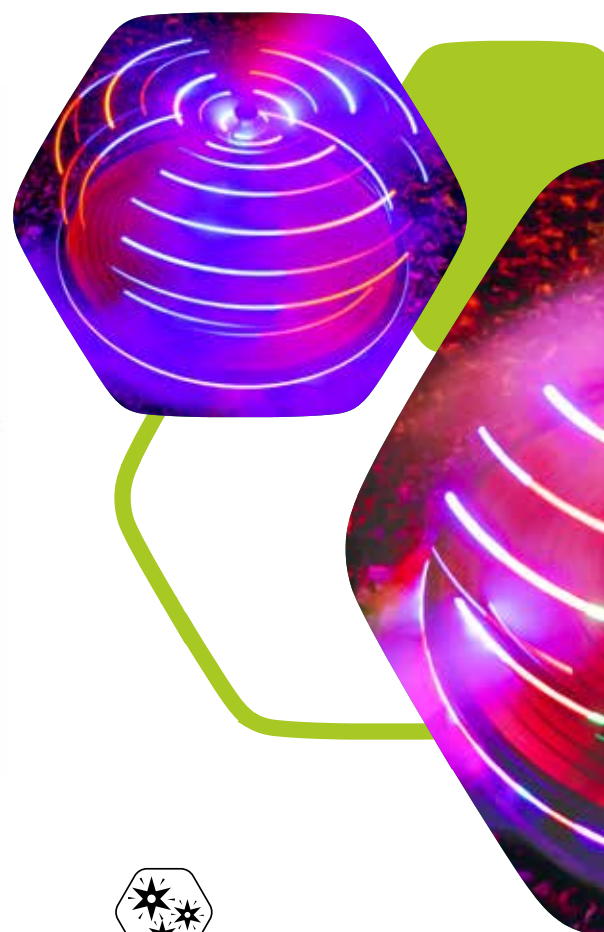

**NORTE 130 LUMO**  
GK-RO-201-L-H



<b>NORTE 130 LUMO PLAY</b>	GK-RO-201-LP	1.30 x 1.30 x 0.80 m	5.30 x 5.30 m	1.0 m	2+	4
<b>NORTE 130 LUMO</b>	GK-RO-201-L-H	1.30 x 1.30 x 0.80 m	5.30 x 5.30 m	1.0 m	2+	4

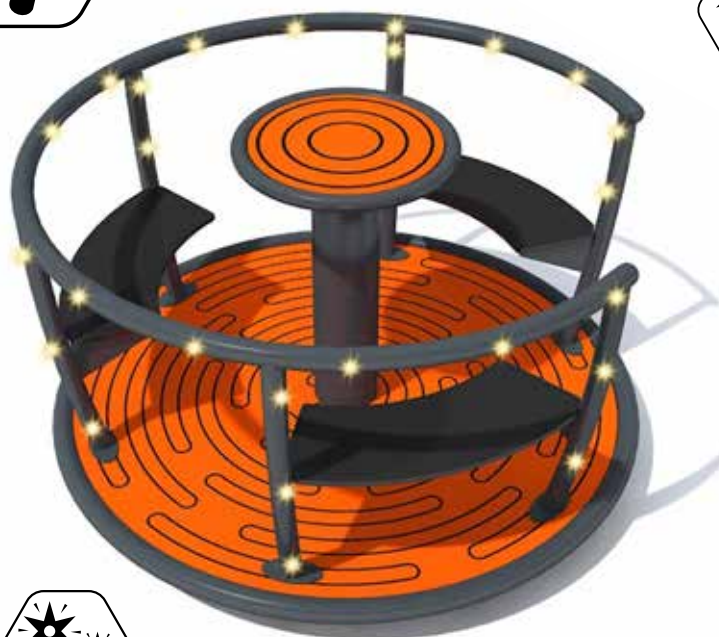

**TORNADO 130 LUMO PLAY**  
GM0147-1p-LP-H

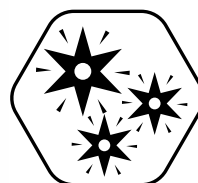
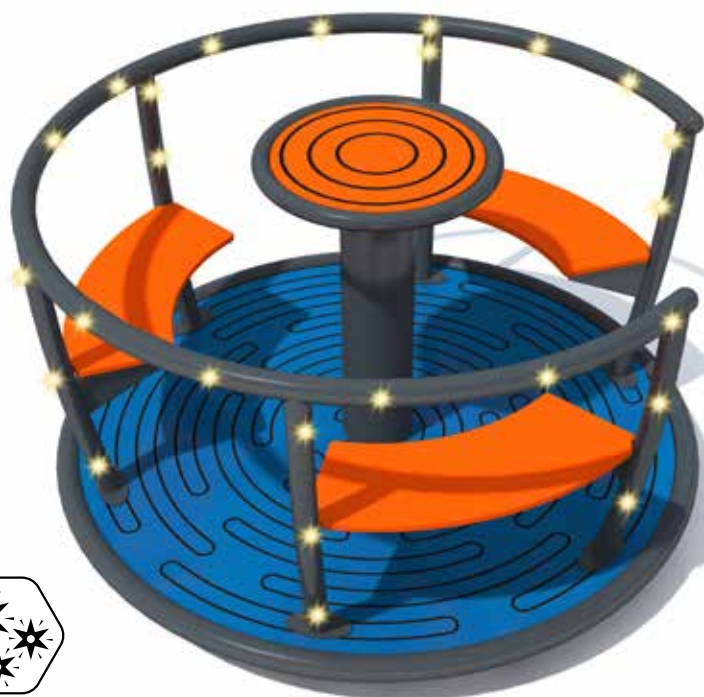

**TORNADO 130 LUMO**  
GM0147-1P-L-H



Product Name	Model	Dimensions (L x W x H)	Length (L)	Width (W)	Height (H)	Children (2+)	Children (4)
<b>TORNADO 130 LUMO PLAY</b>	GM0147-1p-LP-H	1,30 x 1,30 x 0,77	5,30	5,30	1,0	2+	4
<b>TORNADO 130 LUMO</b>	GM0147-1P-L-H	1,30 x 1,30 x 0,77	5,30	5,30	1,0	2+	4



**ATOMIC LUMO PLAY**  
IS-IN-111-LP



**SNAKE LUMO PLAY**  
GM1652-LP

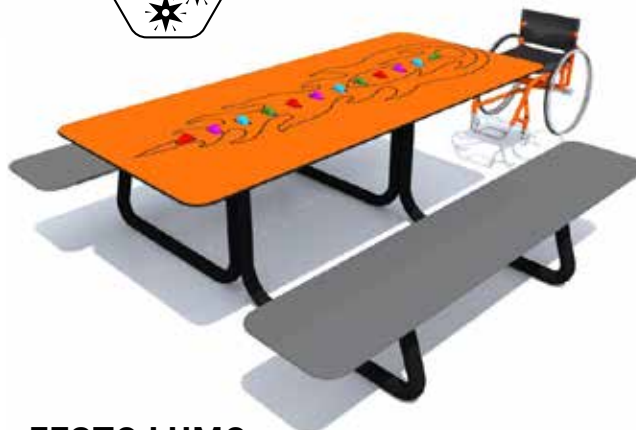

**FESTO MINI LUMO**  
IS-MM-001



**FESTO LUMO**  
IS-MM-002



<b>ATOMIC LUMO PLAY</b>	IS-IN-111-LP			2,14 x 2,14 x 0,83	6,14 x 6,14	1,00	3+	9
<b>SNAKE LUMO PLAY</b>	GM1652-LP			3,28 x 1,52 x 0,80	6,28 x 4,52	0,86	3+	2
<b>FESTO MINI LUMO</b>	IS-MM-001			1,42 x 1,50 x 0,59	4,50 x 4,42	0,59	3+	6
<b>FESTO LUMO</b>	IS-MM-002			2,00 x 2,00 x 0,80	5,00 x 5,00	0,8	3+	8





Linarium







**LINARIUM series comprises rope devices for climbing which are intended for playgrounds and sports facilities. All products of this series are not only a guarantee of great fun, but also develop motor coordination and help to initiate physical activity.**

**LINARIUM eine Serie sehr attraktiver Geräte für Spielplätze, Freizeit- und Sportanlagen. Die Produkte dieser Serie garantieren nicht nur viel Spaß, sondern entwickeln auch die Bewegungskoordination und helfen, körperliche Aktivität zu initiieren.**

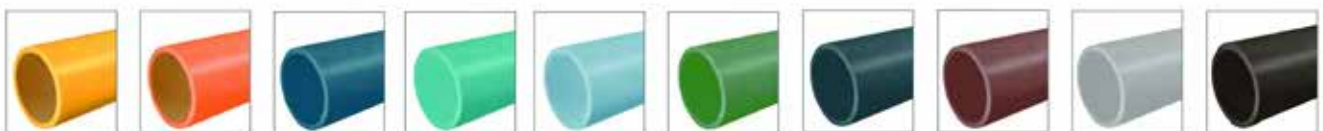
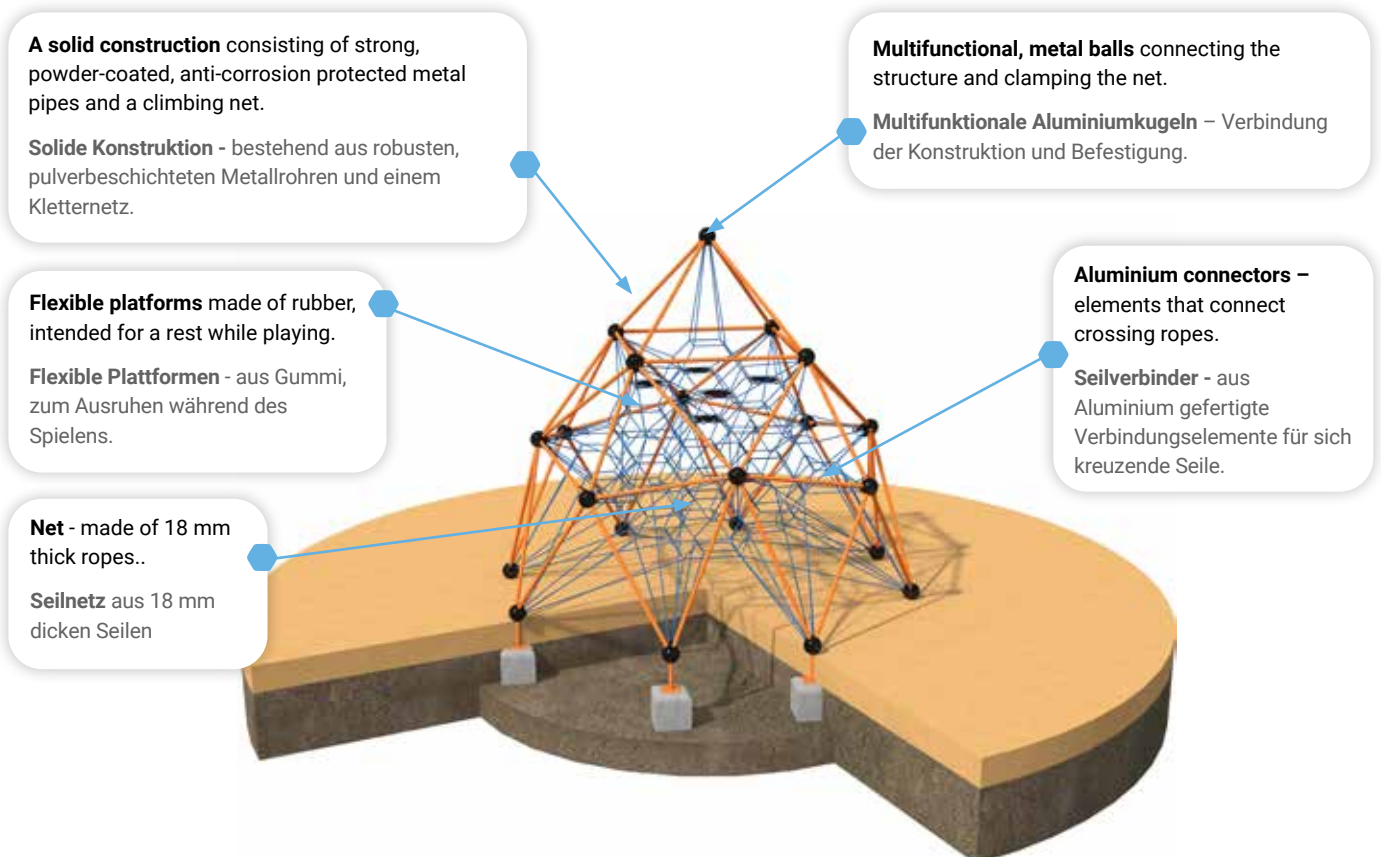

RAL 1003

RAL 2008

RAL 5001

RAL 5018

RAL 5024

RAL 6011

RAL 7026

RAL 8002

RAL 9006

RAL 9005

### Steel construction | Konstruktion aus Stahl



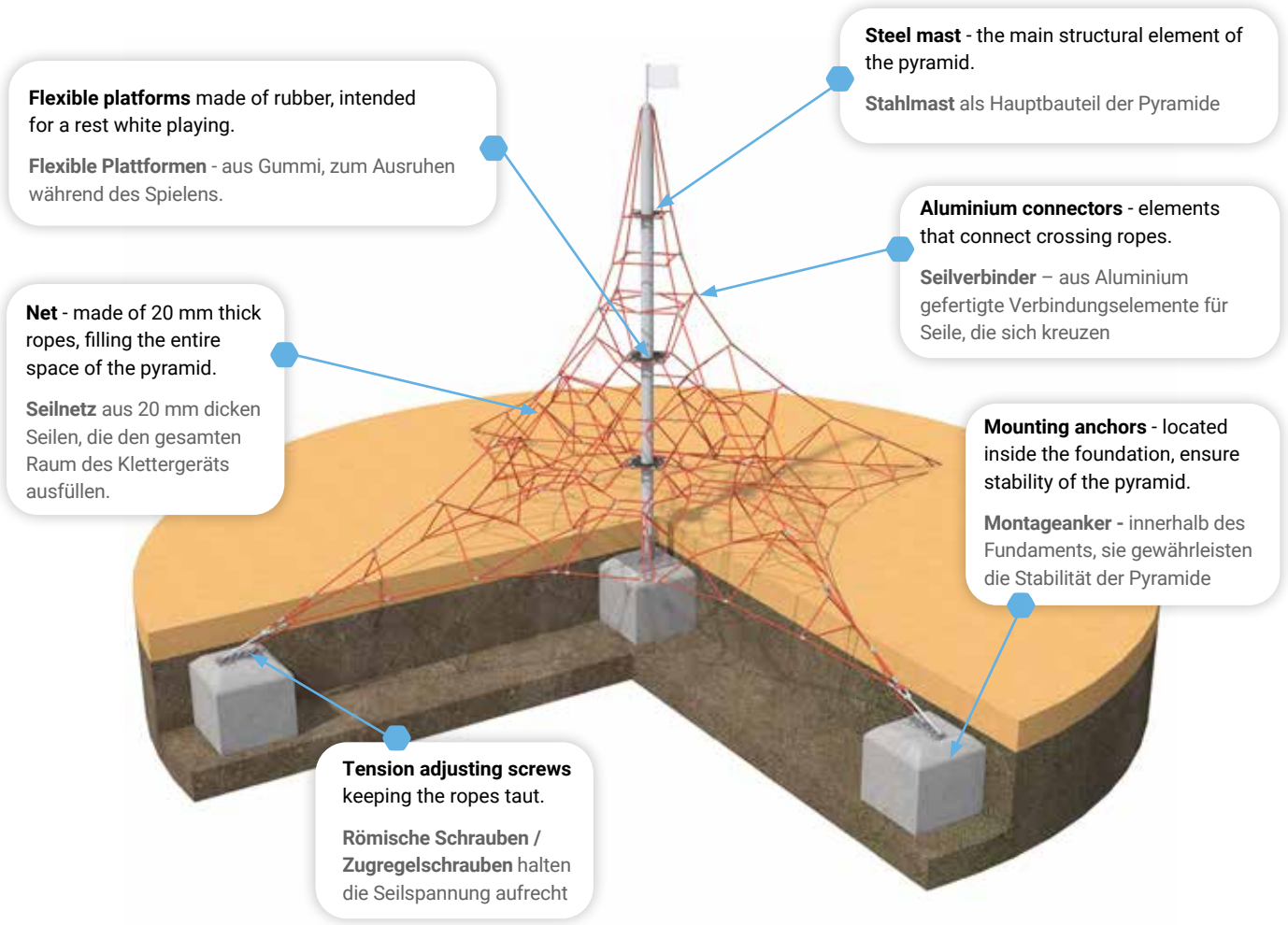

Black Schwarz    Brown Braun    Red Rot    Blue Blau    Green Grün    Gray Grau

**Strong 20 mm thick rope | Starkes 20 mm breites Seil**



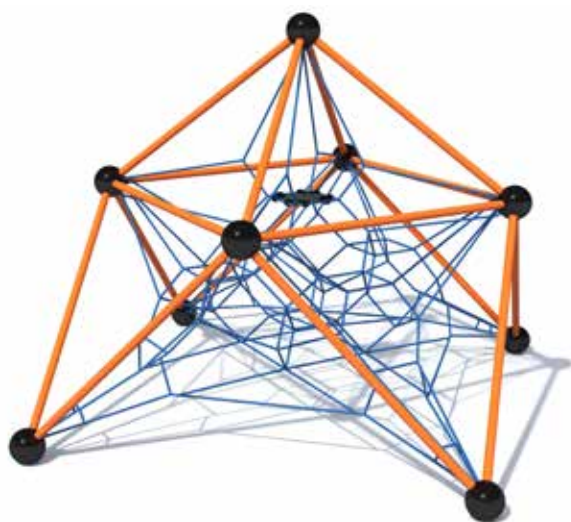

**PINTO 30**  
CR-LI-P30

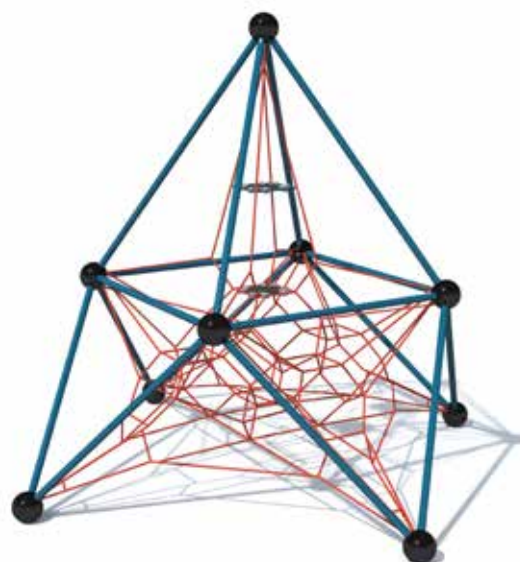

**PINTO 40**  
CR-LI-P40

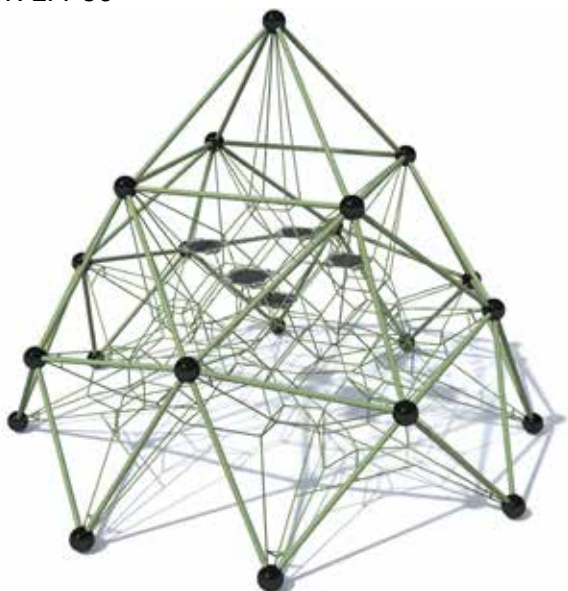

**PINTO 50**  
CR-LI-P50

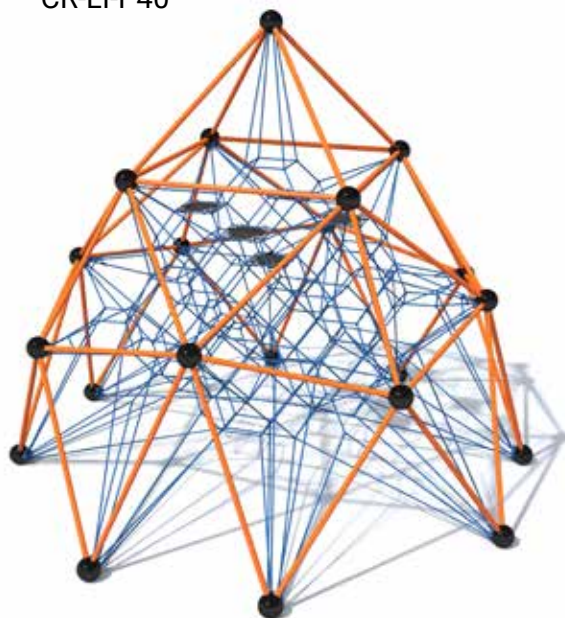

**PINTO 55**  
CR-LI-P55



<b>PINTO 30</b>	CR-LI-P30	3,40 x 3,40 x 3,00	6,83 x 6,83	1,82	3+	22
<b>PINTO 40</b>	CR-LI-P40	3,85 x 3,85 x 4,00	7,25 x 7,25	1,82	3+	22
<b>PINTO 50</b>	CR-LI-P50	5,90 x 5,90 x 5,00	9,15 x 9,15	2,04	3+	42
<b>PINTO 55</b>	CR-LI-P55	5,90 x 5,90 x 5,50	9,75 x 9,75	2,61	3+	43
<b>DIAMANTO 35</b>	CR-LI-D35	4,70 x 4,70 x 3,50	8,30 x 8,30	1,92	3+	49
<b>DIAMANTO 45</b>	CR-LI-D45	4,70 x 4,70 x 4,50	8,15 x 8,15	1,82	3+	54
<b>DIAMANTO 55</b>	CR-LI-D55	4,70 x 4,70 x 5,50	8,15 x 8,15	1,82	3+	56

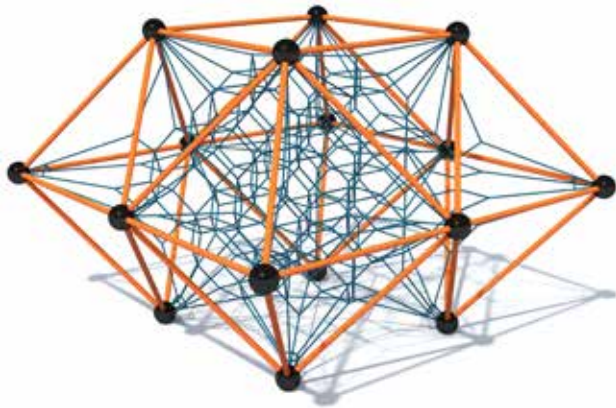

**DIAMANTO 35**  
CR-LI-D35

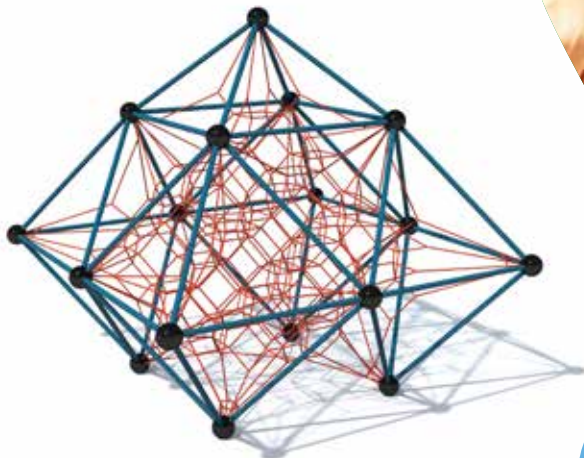

**DIAMANTO 45**  
CR-LI-D45

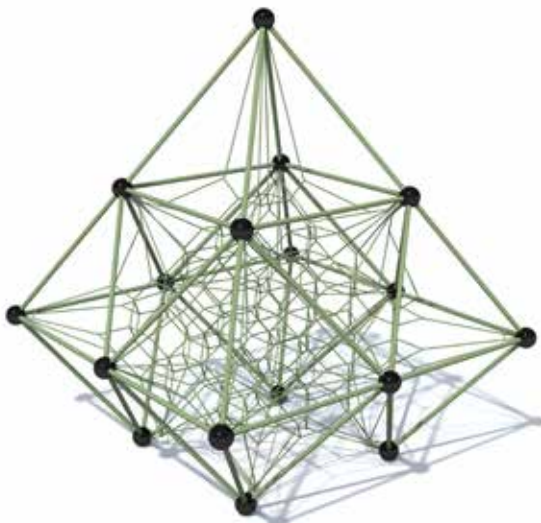

**DIAMANTO 55**  
CR-LI-D55

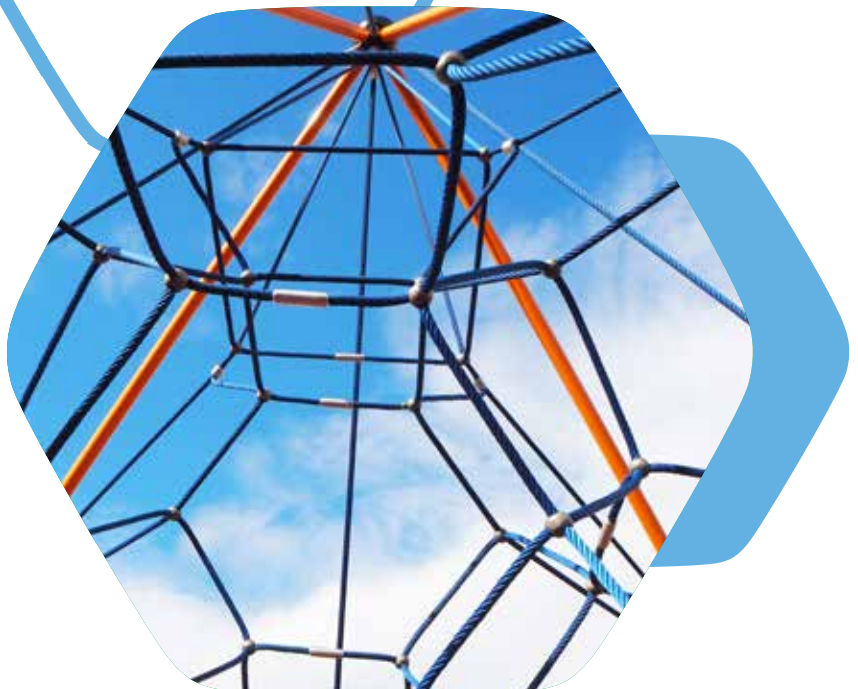

**PIRAMIDO T35**

CR-LI-PT35

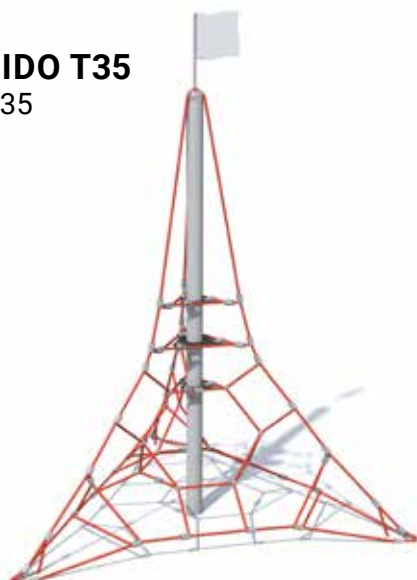
**PIRAMIDO Q85**

CR-LI-PQ85

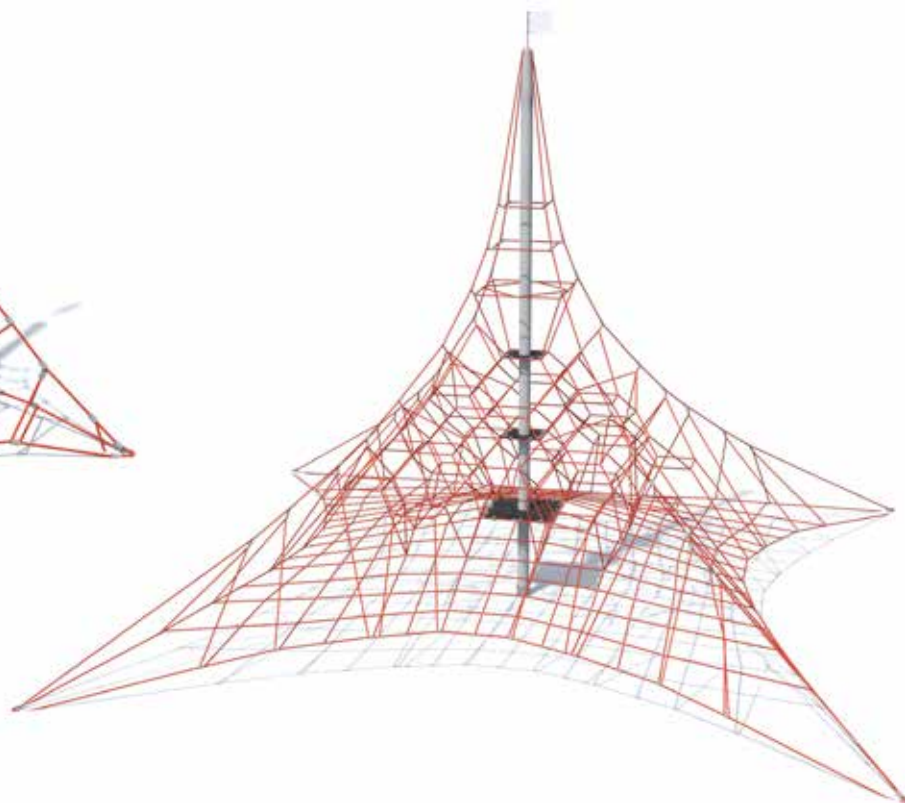

<b>PIRAMIDO T 35</b>	CR-LI-PT35	2,65 x 2,30 x 3,50	5,65 x 5,30	0,30	3+	13
<b>PIRAMIDO Q 35</b>	CR-LI-PQ35	2,80 x 2,80 x 3,50	5,80 x 5,80	0,29	3+	12
<b>PIRAMIDO Q 40</b>	CR-LI-PQ40	5,75 x 5,75 x 4,00	8,75 x 8,75	0,69	3+	28
<b>PIRAMIDO Q 45</b>	CR-LI-PQ45	5,75 x 5,75 x 4,50	8,75 x 8,75	0,69	3+	29
<b>PIRAMIDO Q 55</b>	CR-LI-PQ55	6,95 x 6,95 x 5,50	9,95 x 9,95	0,61	3+	42
<b>PIRAMIDO Q 65</b>	CR-LI-PQ65	7,70 x 7,70 x 6,50	10,70 x 10,70	1,09	3+	48
<b>PIRAMIDO Q 75</b>	CR-LI-PQ75	10,75 x 10,75 x 7,50	13,75 x 13,75	1,22	3+	140
<b>PIRAMIDO Q 85</b>	CR-LI-PQ85	10,75 x 10,75 x 8,50	13,75 x 13,75	1,22	3+	140
<b>PIRAMIDO P 50</b>	CR-LI-PP50	6,90 x 6,55 x 5,00	9,90 x 9,55	1,20	3+	13
<b>PIRAMIDO P 65</b>	CR-LI-PP65	11,00 x 10,50 x 6,50	14,00 x 13,50	0,48	3+	22
<b>PIRAMIDO S 55</b>	CR-LI-PS55	7,80 x 6,75 x 5,50	10,80 x 9,75	0,75	3+	40
<b>PIRAMIDO S 65</b>	CR-LI-PS65	11,80 x 10,20 x 6,50	14,80 x 13,20	0,49	3+	46
<b>PIRAMIDO S 85</b>	CR-LI-PS85	11,80 x 10,20 x 8,50	14,80 x 13,20	0,49	3+	52

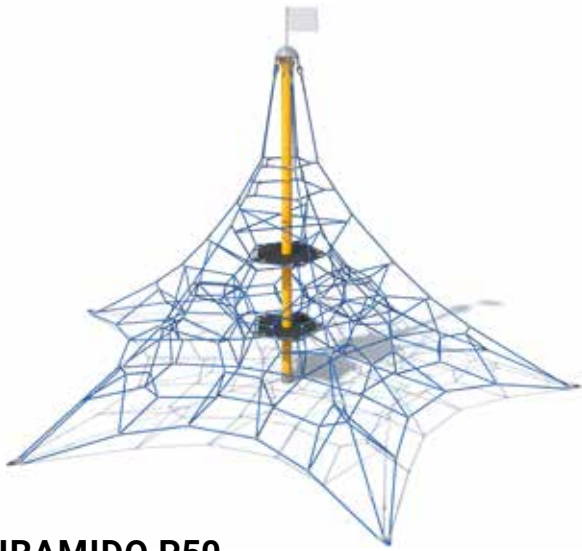

**PIRAMIDO P50**  
CR-LI-PP50

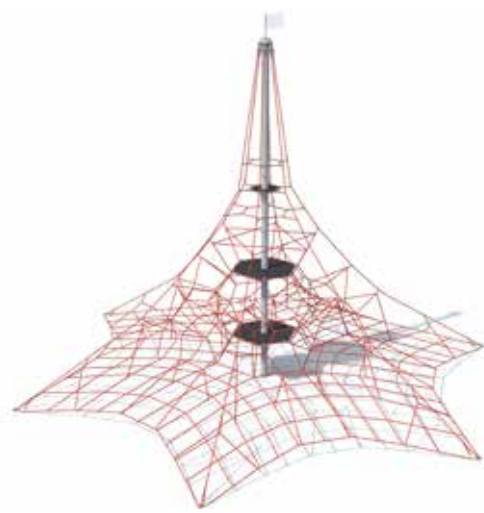

**PIRAMIDO S85**  
CR-LI-PS85



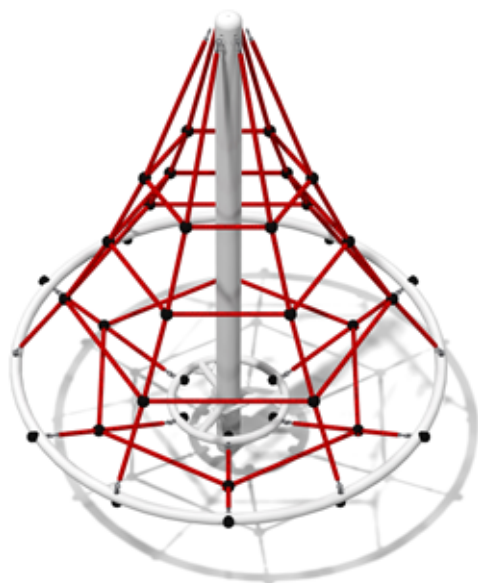

**MT. ASTER**  
GM0701-T

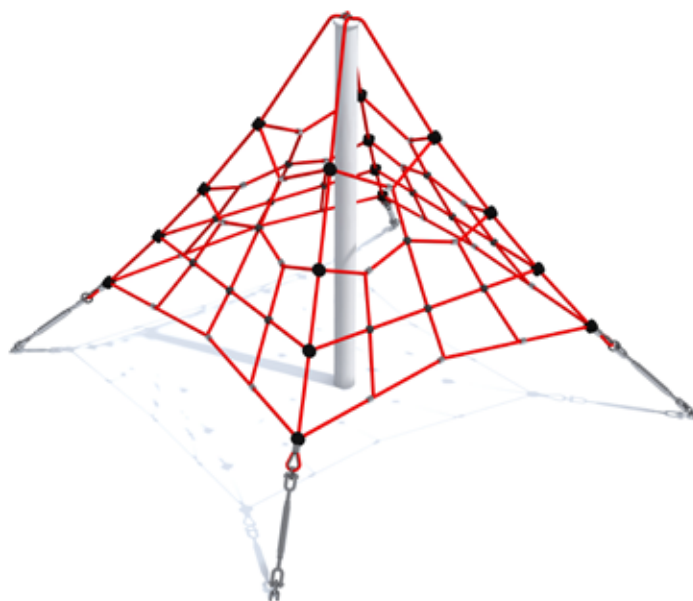

**MT. MNICH**  
W101

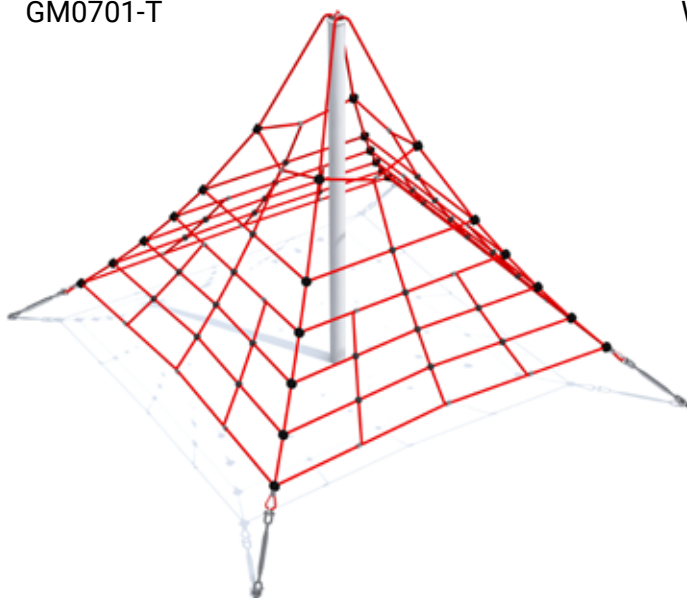

**MT. GERLACH**  
W102

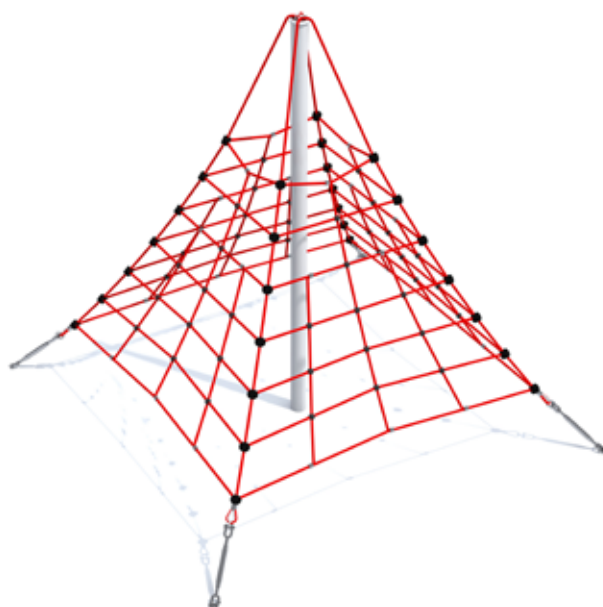

**MT. ROSA**  
W103



<b>MT. ASTER</b>	GM0701-T	1,58 x 1,58 x 2,00	4,58 x 4,58	1,33	3+	4
<b>MT. MNICH</b>	W101	2,60 x 2,60 x 2,00	4,80 x 4,80	1,50	3+	4
<b>MT. GERLACH</b>	W102	3,60 x 3,60 x 2,70	5,60 x 5,60	1,90	3+	8
<b>MT. ROSA</b>	W103	3,10 x 3,10 x 3,00	5,30 x 5,30	2,10	3+	12
<b>MT. ELBRUS</b>	W104	3,60 x 3,60 x 3,50	5,80 x 5,80	2,55	3+	16
<b>MT. RYSY</b>	W105	8,00 x 4,00 x 3,00	11,00 x 7,00	3,00	3+	10

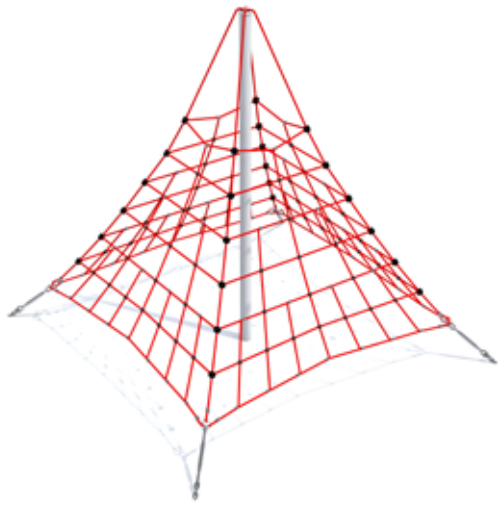

**MT. ELBRUS**  
W104

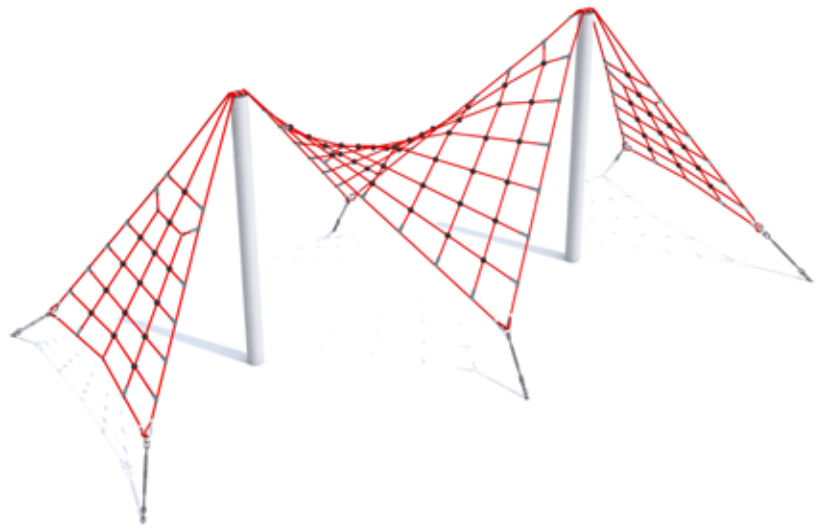

**MT. RYSY**  
W105



**TRANSPORTO**



POLICE



# TRANSPORTO Series

Vehicles are very popular toys found on playgrounds all around the world. Every child can take on the role of a driver, captain, pilot, or astronaut. The TRANSPORTO series stimulates imagination and offers many opportunities for play..

# Serie TRANSPORTO

Fahrzeuge sind sehr beliebte Spielzeuge, die auf Spielplätzen auf der ganzen Welt zu finden sind. Jedes Kind kann in die Rolle eines Fahrers, Kapitäns, Piloten oder Astronauten schlüpfen. Die TRANSPORTO-Serie regt die Fantasie an und bietet zahlreiche Spielmöglichkeiten.

HDPE and HPL panels give the toy its shape and character.

HDPE- und HPL-Platten verleihen dem Spielgerät Form und Charakter.

The powder-coated steel structure ensures safety during play.

Die Konstruktion aus Edelstahl oder pulverbeschichtetem Stahl sorgt für Sicherheit beim Spielen.

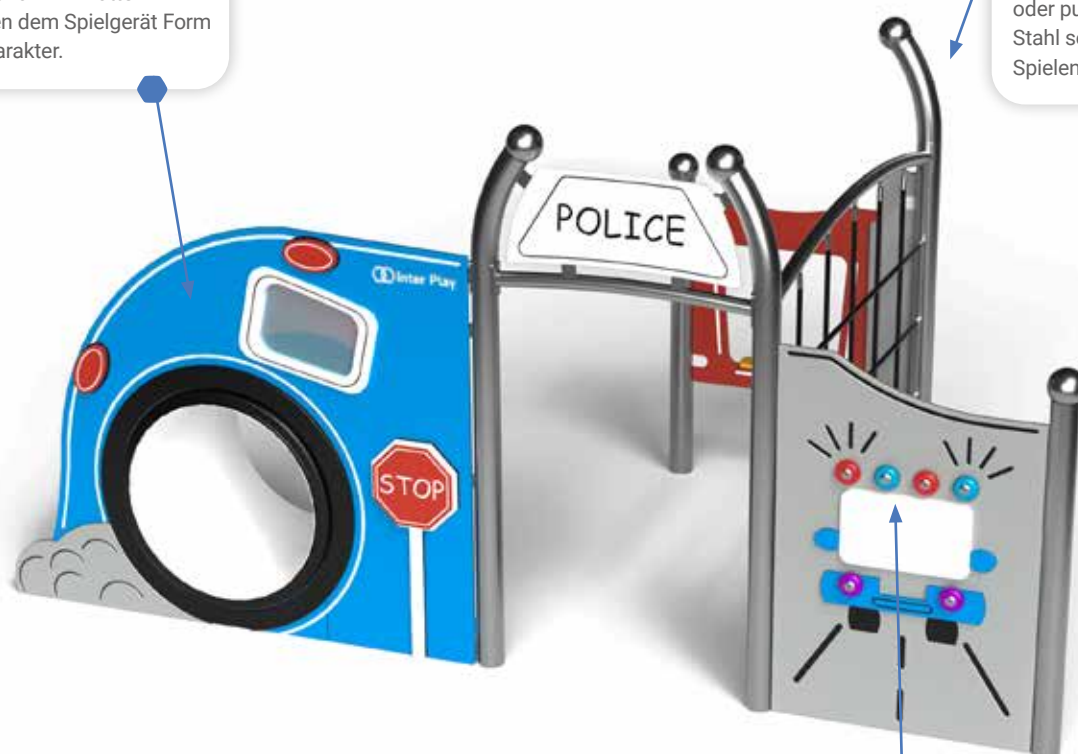

Interactive elements enhance the fun.

Interaktive Elemente erhöhen den Spielspaß und die Attraktivität des Spielgeräts.



**FARM  
BAUERNHOF**  
01-TR-701



**HARBOUR  
HAFEN**  
01-TR-702



**POLICE STATION  
POLIZEI STATION**  
01-TR-703



<b>FARM, BAUERNHOF</b>	01-TR-701	3,27 x 1,73 x 1,58	6,26 x 4,72	1,28	1+	10
<b>HARBOUR, HAFEN</b>	01-TR-702	3,68 x 1,73 x 1,58	6,65 x 4,71	1,28	1+	10
<b>POLICE STATION, POLIZEI STATION</b>	01-TR-703	3,17 x 1,73 x 1,58	6,16 x 4,71	1,28	1+	10

monto





## Embankment slides and tunnels | Hangrutschen und Kriechtunnel

Option I - straight entrance tunnel (Kanalo).  
Option II - sloped entrance tunnel (Tunelo).

Variante I - Eingang senkrecht geschnitten (Kanalo).  
Variante II - Eingang schräg geschnitten (Tunelo)

Stainless steel.  
Edelstahl.

Option I - narrow slide (Gliti).  
Option II - wide slide (Eliri).

Variante I - schmale Rutsche (Gliti).  
Variante II - breite Rutsche (Eliri).

Different lengths of tunnels.

Mehrere Tunnellängen.



Different lengths of slides.  
Mehrere Rutschenlängen.

## Rail slides. | Doppelrutschstange.

Foundations.  
Fundamente.

Any number of handrails available.  
Beliebige Anzahl der Handläufen

Different lengths of slides.  
Mehrere Rutschenlängen.

Stainless steel.  
Edelstahl.

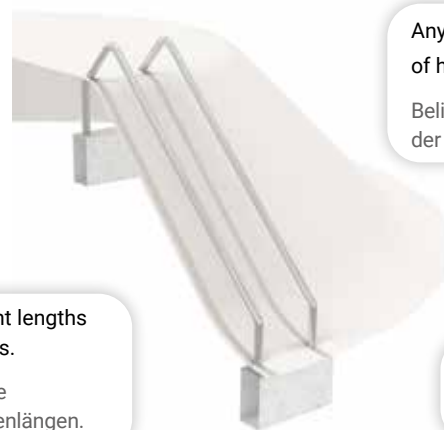

Multiple colors  
Mehrere Farben

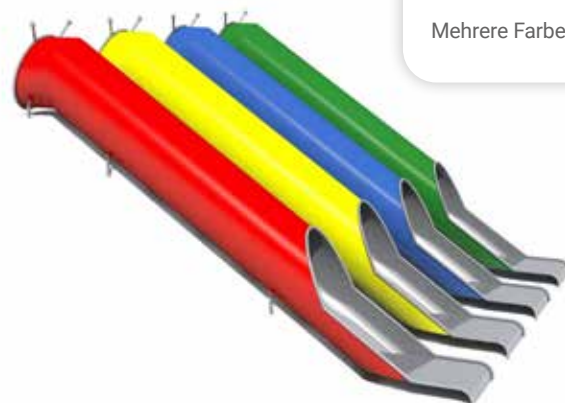
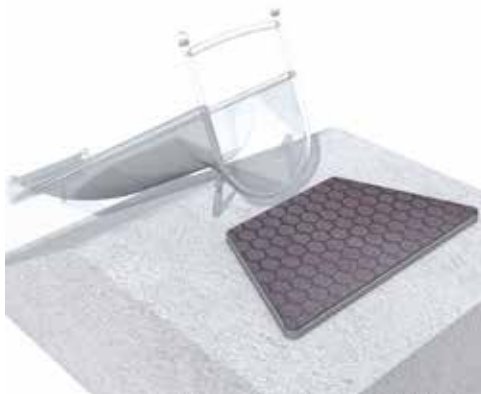

The starting platform eliminates dirt on the slide.  
Additionally, it protects the surface from wear.

Die Startplattform entfernt Schmutz von der Rutsche.  
Zudem schützt sie den Untergrund vor Abnutzung.

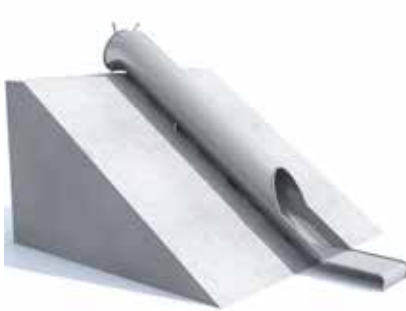

**GLITI****ELIRI****RELO****GLITI-S****TUBO****GLITI INCLUSIVE****GLITI RACE****GLITI / ELIRI / RELO / GLITI RACE / TUBO / GLITI INCLUSIVE - parameters**

PRODUCT PRODUKT	CODE	L1 - EMBANKMENT HEIGHT L1 - BÖSCHUNGS- HÖHE	L2 - EMBANKMENT LENGTH L2 - BÖSCHUNGS- LÄNGE	A - SAFETY ZONE A - SICHERHEITS- ZONE
GLITI H825 ELIRI H825 RELO H825 GLITI H825 RACE	LL-MO-001 LL-MO-021 LL-MO-101 01-MO-371	600-825	1475	1500
GLITI H1000 ELIRI H1000 RELO H1000 GLITI H1000 RACE	LL-MO-007 LL-MO-027 LL-MO-107 01-MO-372	775-1000	1788	1500
GLITI H1350 ELIRI H1350 RELO H1350 GLITI H1350 RACE TUBO H1350	LL-MO-002 LL-MO-022 LL-MO-102 01-MO-373 IS-MO-505	950-1350	2414	2000
GLITI H1700 ELIRI H1700 RELO H1700 GLITI H1700 RACE TUBO H1700 GLITI H1700 INCLUSIVE	LL-MO-003 LL-MO-023 LL-MO-103 01-MO-374 IS-MO-501 01-MO-361	1300-1700	3040	2000

PRODUCT PRODUKT	CODE	L1 - EMBANKMENT HEIGHT L1 - BÖSCHUNGS- HÖHE	L2 - EMBANKMENT LENGTH L2 - BÖSCHUNGS- LÄNGE	A - SAFETY ZONE A - SICHERHEITS- ZONE
GLITI H2050 ELIRI H2050 RELO H2050 GLITI H2050 RACE TUBO H2050 GLITI H2050 INCLUSIVE	LL-MO-004 LL-MO-024 LL-MO-104 01-MO-375 IS-MO-502 01-MO-362	1650-2050	3666	2000
GLITI H2400 ELIRI H2400 RELO H2400 GLITI H2400 RACE TUBO H2400 GLITI H2400 INCLUSIVE	LL-MO-008 LL-MO-028 LL-MO-108 01-MO-376 IS-MO-506 01-MO-363"	2000-2400	4292	2000
GLITI H2750 ELIRI H2750 RELO H2750 GLITI H2750 RACE TUBO H2750 GLITI H2750 INCLUSIVE	LL-MO-005 LL-MO-025 LL-MO-105 01-MO-377 IS-MO-503 01-MO-364	2350-2750	4918	2000
GLITI H3100 ELIRI H3100 RELO H3100 GLITI H3100 RACE TUBO H3100 GLITI H3100 INCLUSIVE	LL-MO-006 LL-MO-026 LL-MO-106 01-MO-378 IS-MO-504 01-MO-365	2700-3100	5544	2000
GLITI-S H3600	IS-MO-401	3100-3500	6259	2000
GLITI-S H4100	IS-MO-402	3600-4000	7153	2000
GLITI-S H4600	IS-MO-403	4100-4500	8047	2000
GLITI-S H5100	IS-MO-404	4600-5000	8941	2000

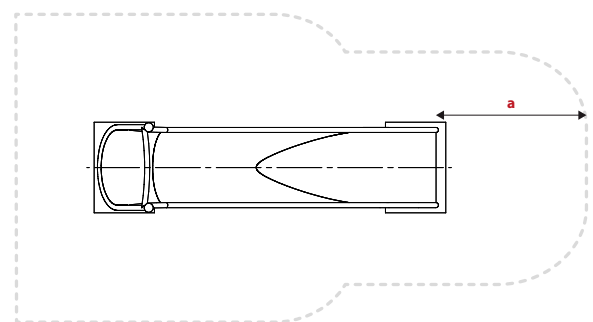
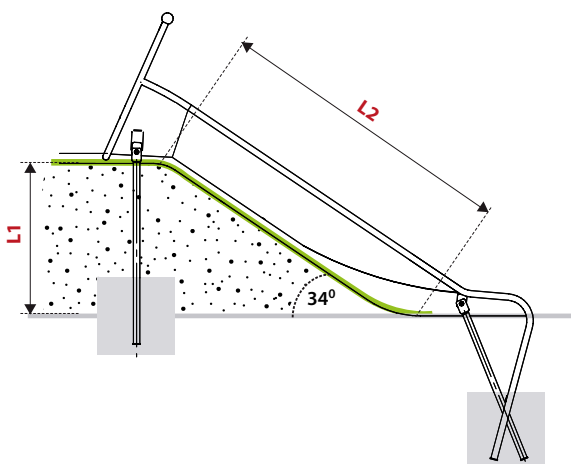

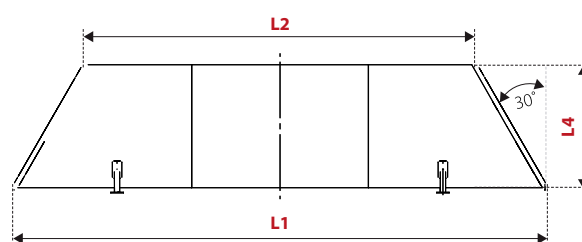
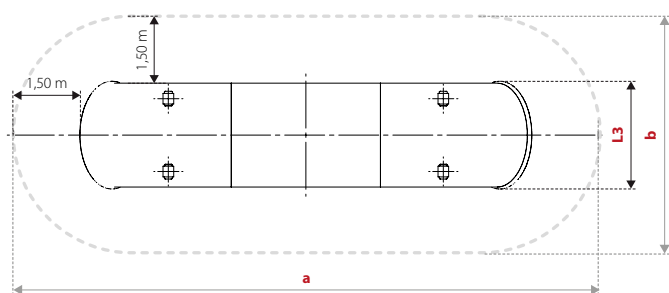

## TUNELO

PRODUCT PRODUKT	CODE CODE	L1	L2	L3	L4	AxB
TUNELO 200	LL-MO-202	2,90 m	2,00 m	0,85 m	0,78 m	5,90 x 3,85 m
TUNELO 250	LL-MO-204	3,40 m	2,50 m	0,85 m	0,78 m	6,40 x 3,85 m
TUNELO 300	LL-MO-206	3,90 m	3,00 m	0,85 m	0,78 m	6,90 x 3,85 m
TUNELO 350	LL-MO-208	4,40 m	3,50 m	0,85 m	0,78 m	7,40 x 3,85 m
TUNELO 400	LL-MO-210	4,90 m	4,00 m	0,85 m	0,78 m	7,90 x 3,85 m
TUNELO 450	LL-MO-212	5,40 m	4,50 m	0,85 m	0,78 m	8,40 x 3,85 m
TUNELO 500	LL-MO-214	5,90 m	5,00 m	0,85 m	0,78 m	8,90 x 3,85 m

**L1** - total length | Gesamtlänge

**L2** - total length | Gesamtlänge

**L3** - total width | Gesamtbreite

**L4** - inner diameter | Innendurchmesser







**A, B** - safety zone | Sicherheitszone



**FRABINA 1200**  
IS-MO-601

**FRABINA 1600**  
IS-MO-602

**FRABINA 2000**  
IS-MO-603

						
<b>FRABINA H 1,2 M</b>	IS-MO-601	3,37 x 0,59 x 1,95 m	6,87 x 3,57 m	1,20 m	3+	1
<b>FRABINA H 1,6 M</b>	IS-MO-602	4,04 x 0,59 x 2,35 m	7,54 x 3,57 m	1,60 m	3+	1
<b>FRABINA H 2,0 M</b>	IS-MO-603	4,79 x 0,59 x 2,75 m	8,29 x 3,57 m	200 m	3+	1

# ROTO





**Roto series has a fun design, eye-catching colors and high quality, durable construction.**

**Die ROTO-Serie hat ein lustiges Design, Drehelemente, auffällige Farben und eine hochwertige, langlebige Konstruktion.**

Galvanized and powder painted steel resistant against rust.

Verzinkter, pulverbeschichteter Stahl.

Polypropylene ropes reinforced with steel cores.

Robuste Polypropylen-Seile.

The walls are made of HDPE boards are resistant to intensive use and are easy to clean. Vivid colors emphasize the aesthetic value of the playground.

Die Anlagewände aus HDPE-Platten für eine intensive Nutzung geeignet; garantieren leichte Reinigung. Lebendigen Farben unterstreichen den ästhetischen Wert des Spielplatzes.

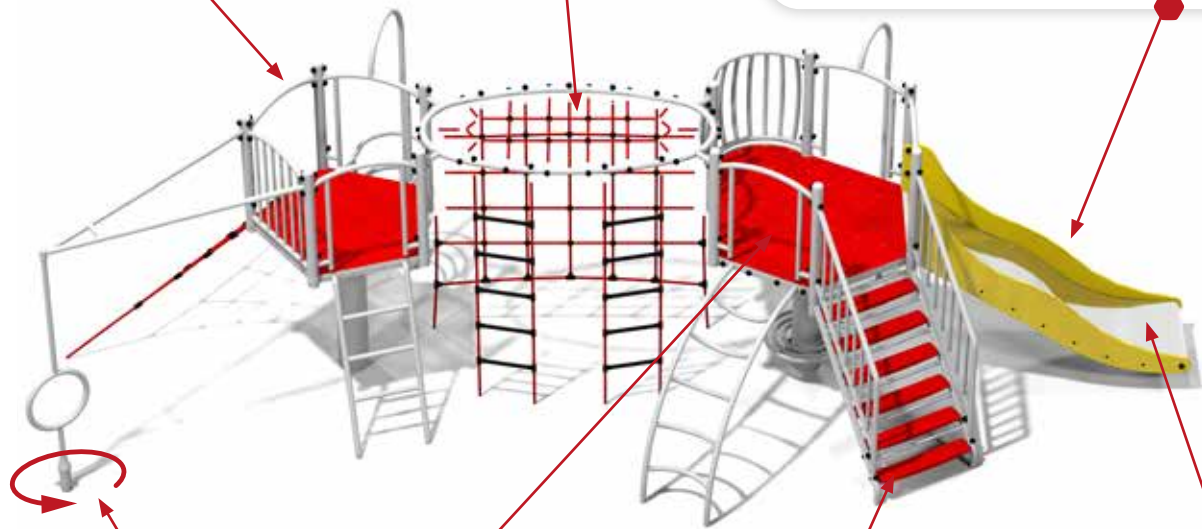

Rotating elements provide great fun.

Rotierende Elemente sorgen für großen Spaß.

Floor and climbing walls made of PE panels with a non-slip structure ensure safety and limit the possibility of uncontrolled slipping.

Boden und Kletterwände aus PE-Kunststoffplatten mit einer rutschfesten Struktur, begrenzen die Möglichkeit des unkontrollierten Rutschens während des Spiels.

Wavy slide provides more fun while playing.

Wellenförmige Rutsche gewährleistet mehr Spaß beim Spielen.

System that slows down swing's arms fall.

Slow System für sanftes Fallen der Schaukelarmen.

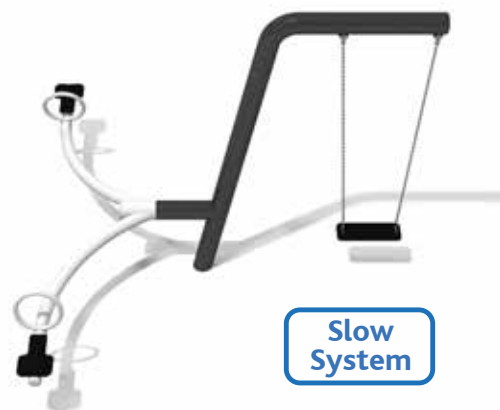

Rotative equipment | Rotierende Spielgeräte

Roundabouts | Klassische Karussells

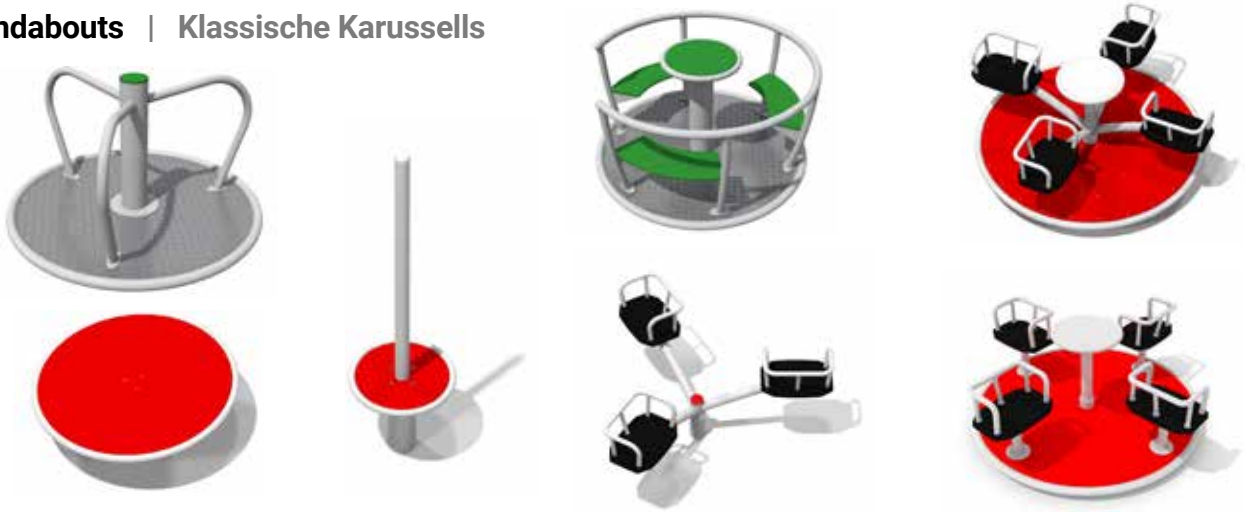

Hanging roundabouts | Rundläufe



Rotative net structures | Rotierende Klettergerüste

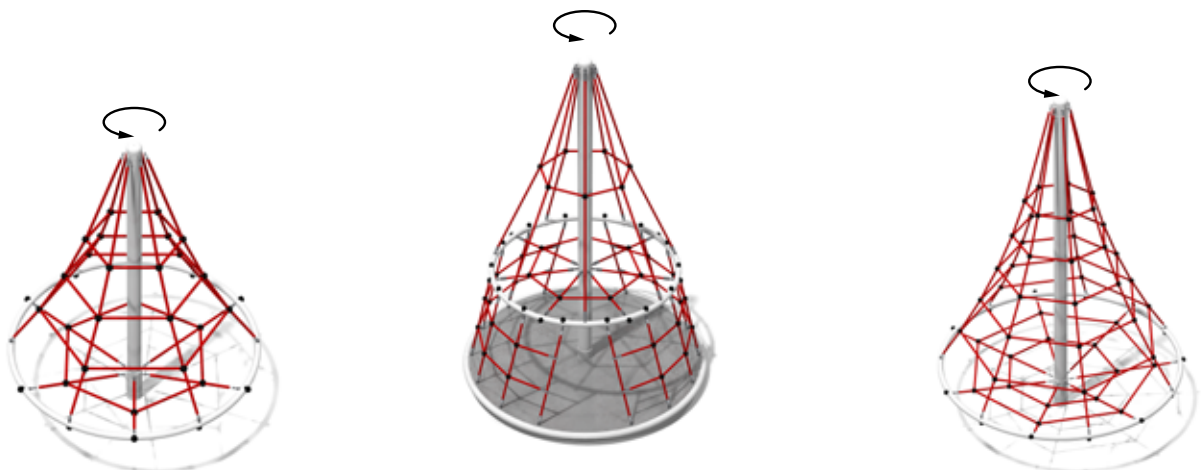



**INDUS**  
GM424501



**ANDROMEDA**  
GM425601





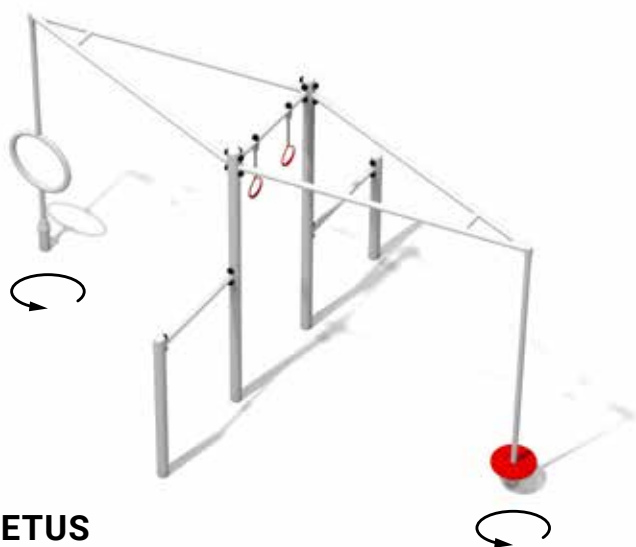

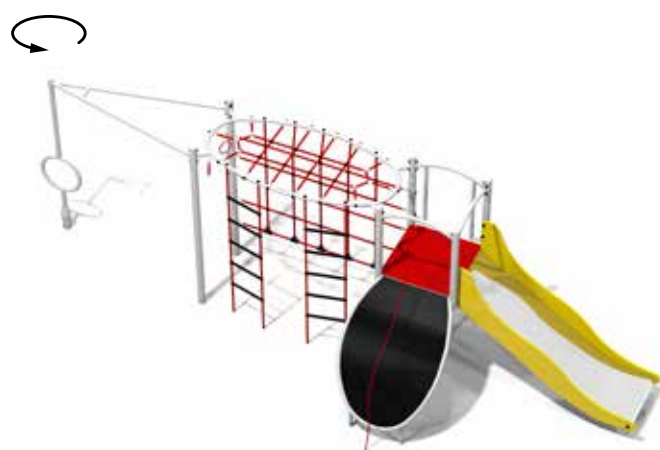

**ORION**  
GM41501



**CETUS**  
GM3400



**GEMINI**  
GM1002

								
<b>INDUS</b>	GM424501			7,67 x 4,47 x 2,35	11,05 x 7,59	1,98	6+	16
<b>ANDROMEDA</b>	GM425601			8,05 x 3,61 x 2,43	11,55 x 6,60	1,98	3+	20
<b>CETUS</b>	GM3400			4,06 x 2,45 x 2,16	7,30 x 5,45	1,65	3+	5
<b>GEMINI</b>	GM41002			6,88 x 2,33 x 2,16	10,36 x 5,40	1,95	3+	8
<b>ORION</b>	GM41501			3,97 x 2,47 x 2,36	7,47 x 5,39	1,26	3+	4
<b>CASSIOPEIA</b>	GM425607			7,32 x 4,23 x 3,16	10,73 x 7,87	1,98	3+	9
<b>SCORPIUS</b>	GM445556			9,22 x 8,91 x 3,16	12,71 x 11,93	1,98	3+	24

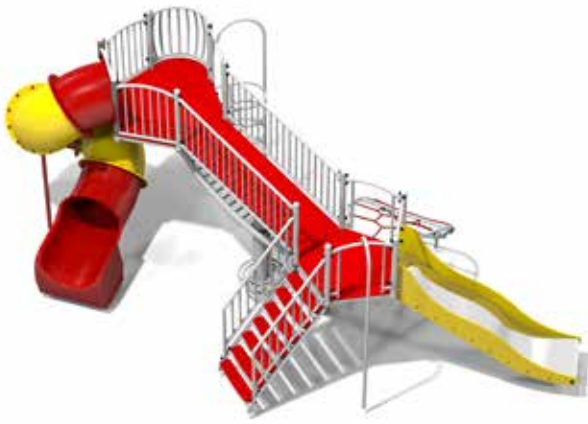

**CASSIOPEIA**  
GM425607



**SCORPIUS**  
GM445556





**ZEPHYR 4**  
GM0714









**MONSOON 4**  
GM0724









**SOLANO 2-1**  
GM-RO-151s



						
<b>ZEPHYR 2</b>	GM0712	3,44 x 0,14 x 2,50	8,00 x 8,00	1,50	6+	2
<b>ZEPHYR 3</b>	GM0713	3,01 x 2,61 x 2,50	8,00 x 8,00	1,50	6+	3
<b>ZEPHYR 4</b>	GM0714	3,44 x 3,44 x 2,50	8,00 x 8,00	1,50	6+	4
<b>MONSOON 2</b>	GM0722	3,44 x 0,14 x 2,50	9,47 x 9,47	1,50	6+	2
<b>MONSOON 3</b>	GM0723	3,01 x 2,61 x 2,50	9,47 x 9,47	1,50	6+	3
<b>MONSOON 4</b>	GM0724	3,44 x 3,44 x 2,50	9,47 x 9,47	1,50	6+	4



						
<b>SOLANO 2-1</b>	GM-RO-151s	3,34 x 0,14 x 2,31	8,40 x 8,40	1,50	6+	2
<b>SOLANO 2-2</b>	GM-RO-151b	3,34 x 0,14 x 2,31	8,40 x 8,40	1,50	6+	2
<b>SOLANO 2-3</b>	GM-RO-151sb	3,34 x 0,14 x 2,31	8,40 x 8,40	1,50	6+	2
<b>SOLANO 3-1</b>	GM-RO-152s	2,92 x 2,54 x 2,31	8,40 x 8,40	1,50	6+	3
<b>SOLANO 3-2</b>	GM-RO-152b	2,92 x 2,54 x 2,31	8,40 x 8,40	1,50	6+	3
<b>SOLANO 3-3</b>	GM-RO-152ssb	2,92 x 2,54 x 2,31	8,40 x 8,40	1,50	6+	3
<b>SOLANO 3-4</b>	GM-RO-152sbb	2,92 x 2,54 x 2,31	8,40 x 8,40	1,50	6+	3

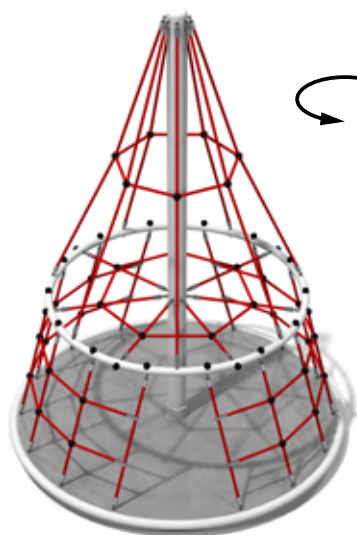

**MT. EVEREST**  
GM0710

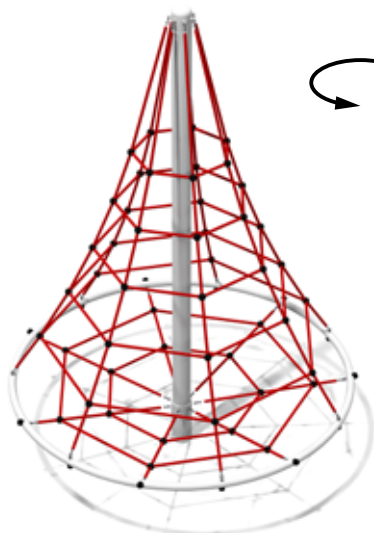

**MT. BLANC**  
GM0704

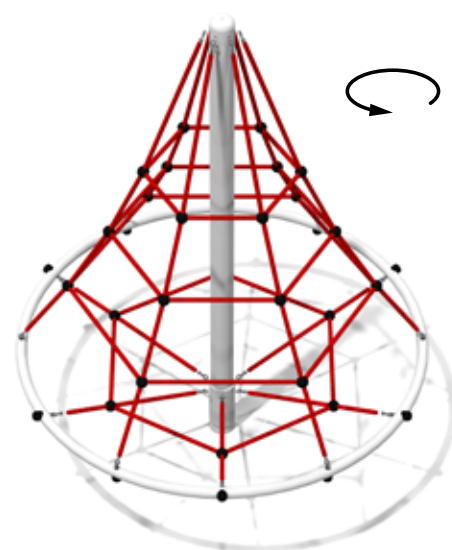

**MT. KASPROWY**  
GM0702

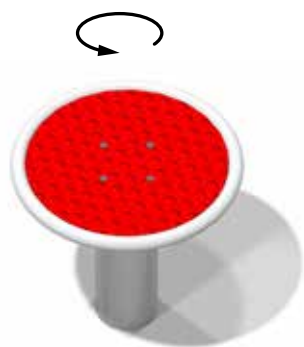





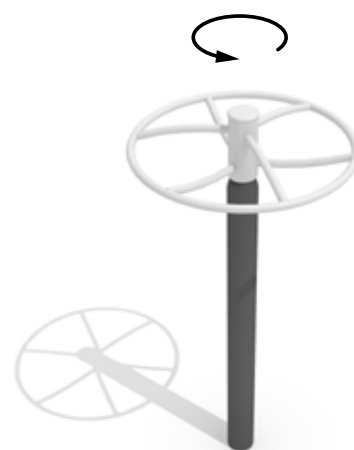

**LOOP**  
GM0410



**PIROUETTE**  
GM0420









**BURAN**  
GM-RO-153

							
<b>MT. EVEREST</b>	GM0710	2,10 x 2,10 x 2,96	6,09 x 6,09	1,98	3+	10	
<b>MT. BLANC</b>	GM0704	2,15 x 2,15 x 3,03	6,15 x 6,15	2,00	3+	8	
<b>MT. KASPROWY</b>	GM0702	1,60 x 1,60 x 2,02	5,60 x 5,60	1,29	3+	6	
<b>LOOP</b>	GM0410	0,30 x 0,30 x 0,29	3,30 x 3,30	1,00	3+	1	
<b>PIROUETTE</b>	GM0420	0,30 x 0,30 x 1,11	3,30 x 3,30	1,00	3+	1	
<b>BURAN</b>	GM-RO-153	0,95 x 0,95 x 2,01	4,95 x 4,95	1,50	6+	3	





						
<b>MISTRAL 3</b>	GM0473P	1,70 x 1,70 x 0,72	5,70 x 5,70	1,00	3+	3
<b>MISTRAL 4</b>	GM0474P	1,70 x 1,70 x 0,72	5,70 x 5,70	1,00	3+	4
<b>BREEZE 3</b>	GK-RO-202	1,58 x 1,58 x 0,73	5,58 x 5,58	1,00	3+	3
<b>BREEZE 4</b>	GK-RO-203	1,58 x 1,58 x 0,73	5,58 x 5,58	1,00	3+	4
<b>TORNADO 130</b>	GM0147-1p-A	1,33 x 1,33 x 0,73	5,33 x 5,33	1,00	3+	4
<b>HURRICANE</b>	GM0324-2P	1,30 x 1,30 x 0,80	5,60 x 5,60	1,00	3+	8
<b>NORTE 130</b>	GK-RO-201-A	1,32 x 1,32 x 0,74	5,32 x 5,32	1,00	3+	6



**MISTRAL 3**  
GM0473P



**MISTRAL 4**  
GM0474P

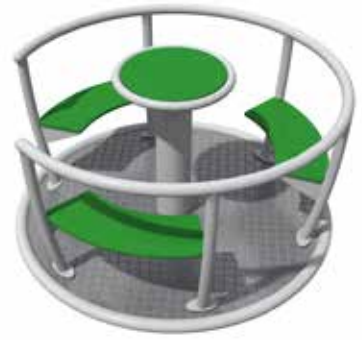

**TORNADO 130**  
GM0147-1p-A



**BREEZE 3**  
GM-RO-202



**BREEZE 4**  
GM-RO-203

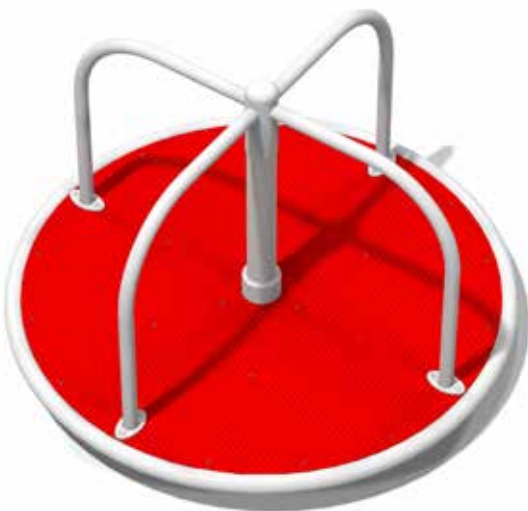

**HURRICANE**  
GM0324-2P

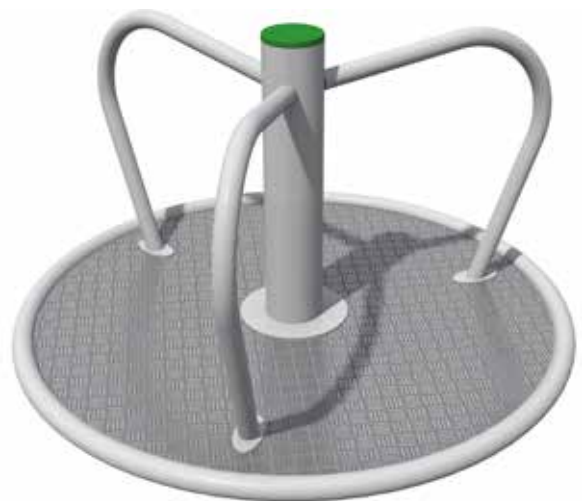

**NORTE 130**  
GK-RO-201-A



**MARIN**  
TO-RO-03



**LESTE**  
TO-RO-02

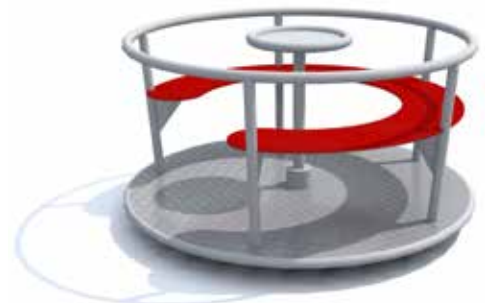

**PAMPERO**  
TO-RO-01

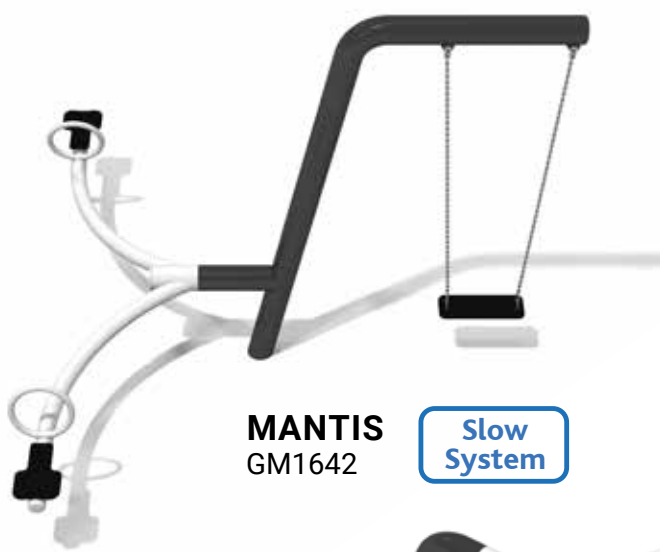

**MANTIS**  
GM1642

Slow  
System





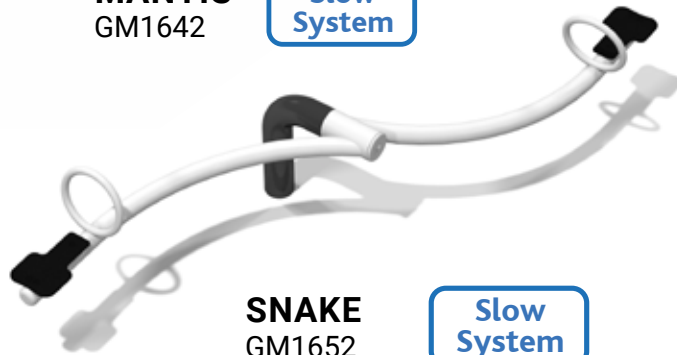



**STARGATE**  
GM1606



**SNAKE**  
GM1652

Slow  
System

						
<b>MARIN</b>	TO-RO-03	0,66 x 0,66 x 1,20	4,66 x 4,66	1,00	3+	1
<b>LESTE</b>	TO-RO-02	1,50 x 1,50 x 0,95	5,50 x 5,50	1,00	3+	6
<b>PAMPERO</b>	TO-RO-01	1,50 x 1,50 x 0,80	5,50 x 5,50	1,00	3+	4
<b>SNAKE</b>	GM1652	3,00 x 1,42 x 1,13	6,00 x 4,42	0,86	3+	2
<b>MANTIS</b>	GM1642	2,80 x 3,00 x 2,29	4,67 x 7,50	1,27	3+	3
<b>STARGATE</b>	GM1606	2,59 x 0,32 x 2,16	1,75 x 7,34	1,20	3+	1





**CRAB**  
GM1654









**OCTOPUS**  
GM1656



**DIGO**  
KS-RO-01



**LOLLIPOP**  
GM7001

								
<b>CRAB</b>	GM1654			3,00 x 2,40 x 1,13	5,40 x 6,00	0,86	3+	4
<b>OCTOPUS</b>	GM1656			5,44 x 4,78 x 1,16	7,78 x 8,44	0,86	3+	6
<b>DIGO</b>	KS-RO-01			1,42 x 0,55 x 0,88	5,20 x 5,20	1,00	3+	1
<b>ASPEN 20M</b>	GM2001-20			23,62 x 4,01 x 3,85	24,0 x 4,45	1,30	6+	1
<b>ASPEN 25M</b>	GM2001-25			28,87 x 4,25 x 4,13	29,0 x 4,45	1,58	6+	1
<b>ASPEN 30M</b>	GM2001-30			34,01 x 4,30 x 4,35	34,5 x 4,45	1,80	6+	1
<b>LOLLIPOP</b>	MA7001			0,6 x 0,05 x 2,18	3,59 x 3,04	-	-	-

**ASPEN**  
GM2001-20



# OUTDOOR GAMES

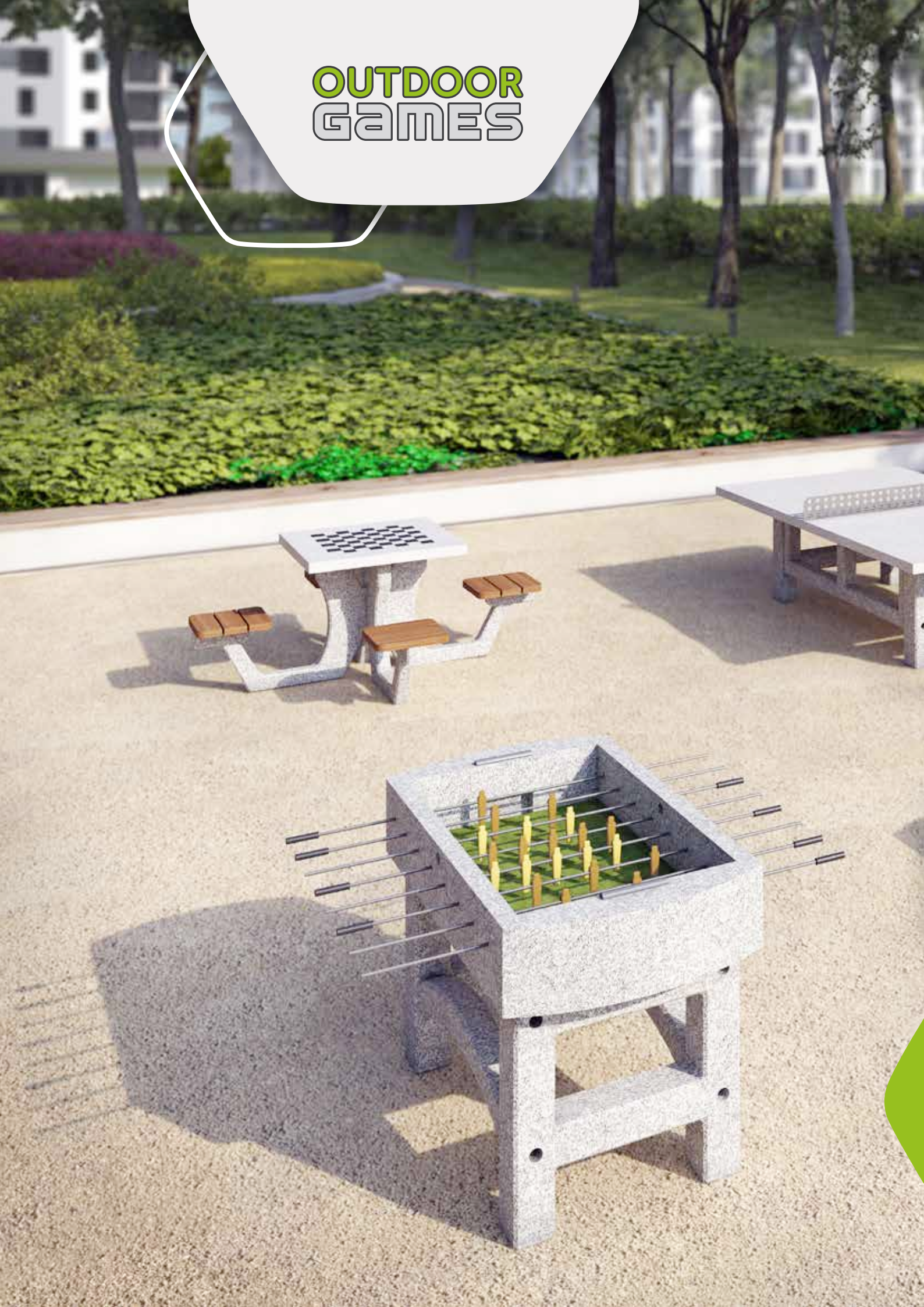





**TENNIS TABLE 01/02**  
**TISCHTENNISPLATTE 01/02**  
KT-02-CR-007/008

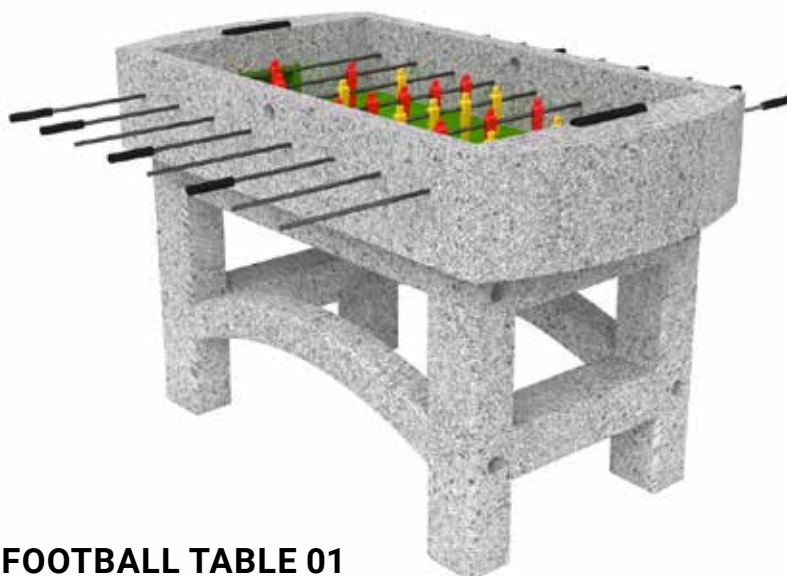

**FOOTBALL TABLE 01**  
**KICKERTISCH 01**  
KT-02-CR-009



**TENNIS TABLE 01/02**

KT-02-CR-007/008

2,74 x 1,52 x 0,78

**FOOTBALL TABLE 01**

KT-02-CR-009

1,52 x 0,80 x 0,88

**TABLE FOR CHESS - CHECKERS 01**

KT-02-CR-001

2,00 x 2,00 x 0,81

**PICNIC TABLE 01**

KT-02-CR-011

2,00 x 2,00 x 0,81

**PICNIC TABLE 02**

KT-02-CR-012

2,00 x 2,00 x 0,78

**Concrete games tables | Spieltische aus Beton**



**TABLE FOR CHESS -  
CHECKERS 01**  
KT-02-CR-001



**TABLE FOR LUDO GAME 01**  
KT-02-CR-002



**PICNIC TABLE 01**  
KT-02-CR-011



**PICNIC TABLE 02**  
KT-02-CR-012



**TABLE FOR CHESS - CHECKERS 03**

T-02-CR-005

**PICNIC TABLE 03**

KT-02-CR-013

**TABLE FOR LUDO GAME 03**

KT-02-CR-006



<b>TABLE FOR CHESS - CHECKERS 03</b>	KT-02-CR-005	2,00 x 2,00 x 0,83	-
<b>PICNIC TABLE 03</b>	KT-02-CR-013	2,00 x 2,00 x 0,83	-
<b>TABLE FOR LUDO GAME 03</b>	KT-02-CR-006	2,00 x 2,00 x 0,83	-
<b>TABLE FOR CHESS - CHECKERS / LUDO GAME</b>	KT-02-CR-010	2,00 x 2,00 x 0,78	-
<b>TABLE FOR CHESS - CHECKERS 02</b>	KT-02-CR-003	2,00 x 2,00 x 0,78	-
<b>TABLE FOR LUDO GAME 02</b>	KT-02-CR-004	2,00 x 2,00 x 0,78	-



**TABLE FOR CHESS -  
CHECKERS / LUDO GAME 02**  
KT-02-CR-010



**TABLE FOR CHESS - CHECKERS 02**  
KT-02-CR-003



**TABLE FOR LUDO GAME 02**  
KT-02-CR-004

# URBAN FURNITURE





**TOPAZO**

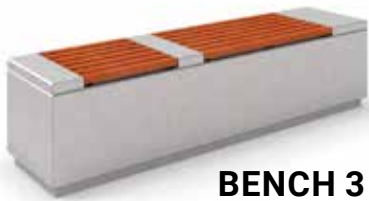

**BENCH 3**

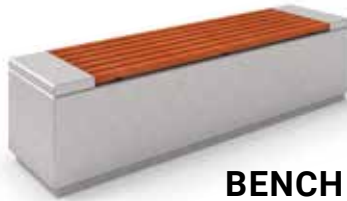

**BENCH 2**



**BENCH 4**



**BENCH 1**

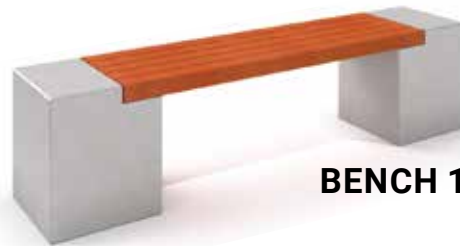

**BENCH 11**



**BENCH 5**



**BENCH 7**



**TRASH BIN 5**



**ARMITA**



**BENCH 9**

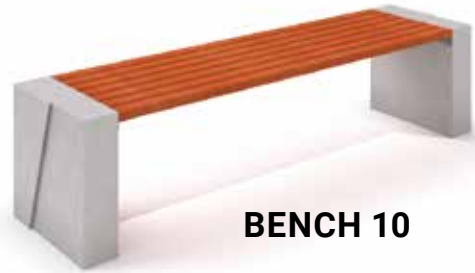

**BENCH 10**

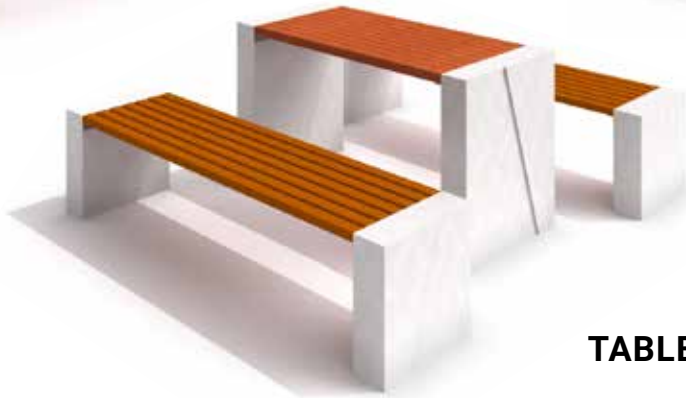

**TABLE 2**



**TRASH BIN 1**



**KRETO**

---



**BENCH 5**



**BENCH 6**



**TRASH BIN 7**

**PERLO**

---

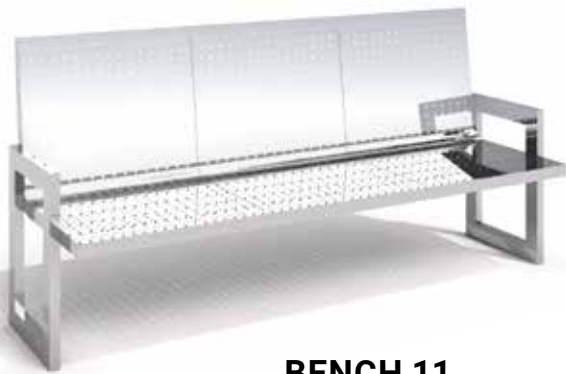

**BENCH 11**

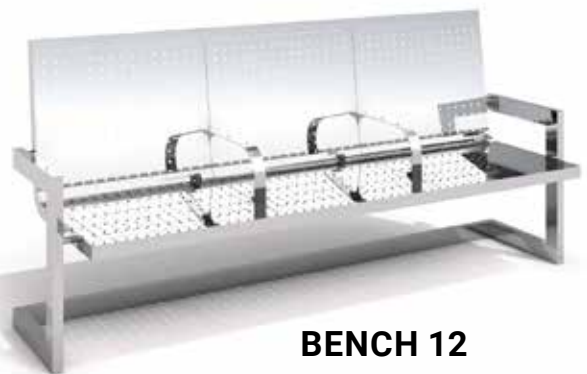

**BENCH 12**



**BICYCLE RACK 24**



**TRASH BIN 6**



**TRASH BIN 7**

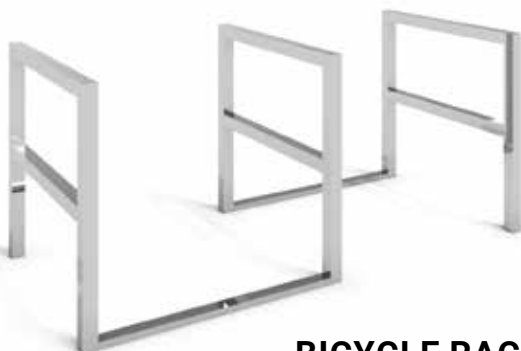

**BICYCLE RACK 6**

**MALAKITO**

---

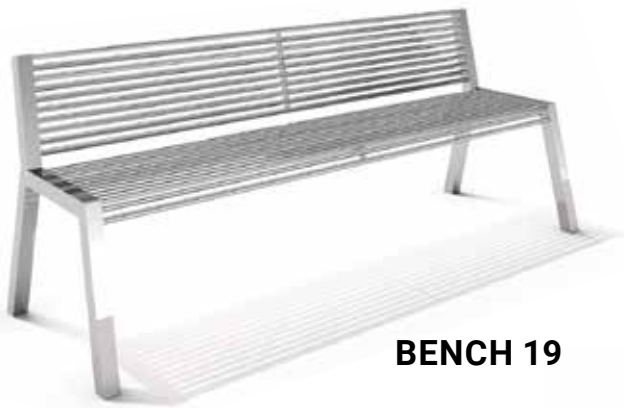

**BENCH 19**



**BENCH 20**



**TRASH BIN 4**



## JAGO

---



BENCH 16



BENCH 17

TRASH BIN 7



TRASH BIN 5

TRASH BIN 6



BICYCLE RACK 8



BICYCLE RACK 10



BICYCLE RACK 26

## SAFIRO

---



BENCH 5



BENCH 6



BENCH 7



TRASH BIN 1



TRASH BIN 2



BICYCLE RACK 6

**KRONO**

---



**BENCH 21**



**BENCH 15**



**BENCH 3**



**BICYCLE RACK 2**



**BICYCLE RACK 8**



**BICYCLE RACK 1**



Benches made of Deco concrete | Sitzbänke aus Dekobeton



DECO CONCRETE BENCH 1



DECO CONCRETE BENCH 2



DECO CONCRETE BENCH 3



DECO CONCRETE BENCH 4



DECO CONCRETE BENCH 5



DECO CONCRETE BENCH 6



DECO CONCRETE BENCH 7



DECO CONCRETE BENCH 8



DECO CONCRETE BENCH 9



DECO CONCRETE BENCH 10



DECO CONCRETE BENCH 11



DECO CONCRETE BENCH 12



DECO CONCRETE BENCH 13



DECO CONCRETE BENCH 14

Concrete benches | Sitzbänke aus gewaschenem Beton



CONCRETE BENCH 1



CONCRETE BENCH 2



CONCRETE BENCH 5



CONCRETE BENCH 6



CONCRETE BENCH 7



CONCRETE BENCH 8



CONCRETE BENCH 9



CONCRETE BENCH 3



CONCRETE PLANTER SET WITH BENCH 1



CONCRETE PLANTER SET WITH BENCH 2



CONCRETE PLANTER SET WITH BENCH 3



CONCRETE BENCH 4



CONCRETE PLANTER SET WITH BENCH 1



CONCRETE PLANTER SET WITH BENCH 2



CONCRETE PLANTER SET WITH BENCH 3

**Stainless steel and steel benches | Edelstahl Sitzbänke**



**STAINLESS STEEL BENCH 1**



**STAINLESS STEEL BENCH 2**



**STAINLESS STEEL BENCH 3**



**STAINLESS STEEL BENCH 4**



**STAINLESS STEEL BENCH 5**



**STAINLESS STEEL BENCH 6**



**STAINLESS STEEL BENCH 7**



**STAINLESS STEEL BENCH 8**



**STAINLESS STEEL BENCH 9**



**STAINLESS STEEL BENCH 10**



**STAINLESS STEEL BENCH 11**



**STAINLESS STEEL BENCH 12**



**STAINLESS STEEL BENCH 13**



**STAINLESS STEEL BENCH 14**



**STAINLESS STEEL BENCH 15**



**STAINLESS STEEL BENCH 16**



**STAINLESS STEEL BENCH 17**



**STAINLESS STEEL BENCH 18**



**STAINLESS STEEL BENCH 19**



**STAINLESS STEEL BENCH 20**



**STAINLESS STEEL BENCH 21**



Decorative trash bins made of Deco concrete | Mülleimer aus Dekobeton



DECO WHITE CONCRETE TRASH BIN 1



DECO WHITE CONCRETE TRASH BIN 2

Concrete trash bins | Mülleimer aus gewaschenem Beton



CONCRETE TRASH BIN 1



CONCRETE TRASH BIN 2



CONCRETE TRASH BIN 3



CONCRETE TRASH BIN 4



CONCRETE TRASH BIN 5



CONCRETE TRASH BIN 6



CONCRETE TRASH BIN 7

Stainless steel and steel trash bins | Edelstahl Mülleimer



STAINLESS STEEL TRASH BIN 8



STAINLESS STEEL TRASH BIN 1



STAINLESS STEEL TRASH BIN 2



STAINLESS STEEL TRASH BIN 3



STAINLESS STEEL TRASH BIN 4



STAINLESS STEEL TRASH BIN 5



STAINLESS STEEL TRASH BIN 6



STAINLESS STEEL TRASH BIN 7



Stainless steel and steel bicycle racks | Edelstahl Fahrradständer



**STAINLESS STEEL  
BICYCLE RACK 1**



**STAINLESS STEEL  
BICYCLE RACK 2**



**STAINLESS STEEL  
BICYCLE RACK 4**



**STAINLESS STEEL  
BICYCLE RACK 5**



**STAINLESS STEEL  
BICYCLE RACK 6**



**STAINLESS STEEL  
BICYCLE RACK 7**



**STAINLESS STEEL  
BICYCLE RACK 8**



**STAINLESS STEEL  
BICYCLE RACK 10**



**STAINLESS STEEL  
BICYCLE RACK 11**



**STAINLESS STEEL  
BICYCLE RACK 12**



**STAINLESS STEEL  
BICYCLE RACK 13**



**STAINLESS STEEL  
BICYCLE RACK 14**

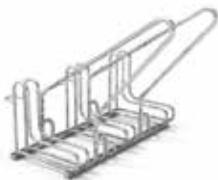

**STAINLESS STEEL  
BICYCLE RACK 15**



**STAINLESS STEEL  
BICYCLE RACK 16**

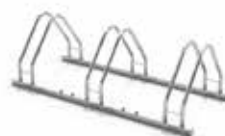

**STAINLESS STEEL  
BICYCLE RACK 17**



**STAINLESS STEEL  
BICYCLE RACK 18**

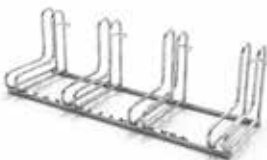

**STAINLESS STEEL  
BICYCLE RACK 19**



**STAINLESS STEEL  
BICYCLE RACK 20**

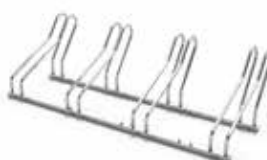

**STAINLESS STEEL  
BICYCLE RACK 21**



**STAINLESS STEEL  
BICYCLE RACK 22**



**STAINLESS STEEL  
BICYCLE RACK 24**



**STAINLESS STEEL  
BICYCLE RACK 25**



**STAINLESS STEEL  
BICYCLE RACK 26**



A VOTRE SERVICE DEPUIS 1995



**English**

[direction@healthsport.ch](mailto:direction@healthsport.ch)

+41 21 903 57 67

<https://healthsport.ch/>

**Deutschland / Österreich**

[direction@healthsport.ch](mailto:direction@healthsport.ch)

+41 21 903 57 67

<https://healthsport.ch/>