



A VOTRE SERVICE DEPUIS 1995



Rte de Taillepied 44 1095 Lutry Tél : (021) 903 57 67
www.healthsport.ch direction@healthsport.ch

Patient Care Devices

2025/2026

This catalogue contains information on, among other things, medical devices that should be handled by qualified medical personnel and used in accordance with the instructions for use or the label.

Your comfort and safety is important to us



Taking care of a person with mobility problems requires a lot of commitment on the part of the caregiver. Looking after an immobilized person, especially when moving or lifting them, often is connected with putting physical effort, which can expose the caregiver to muscle strain or spine injuries.

Lifting devices are an excellent solution for daily care of people with mobility problems, making sitting, standing, and moving easier. To facilitate everyday care activities, Meden-Inmed produces modern patient lifts – devices which significantly improve the quality of life for users and make the work of caregivers much easier. These devices are indispensable in nursing homes, hospitals, rehabilitation centers, and home care settings.

We offer comprehensive solutions, both for standing support and for transporting patients in full suspension. This catalogue is designed to help you choose the right lift model that will meet the needs of both end users and their caregivers.



PatiHoist



Lifteo ELA



Levitop Standard



Levitop Comfort



Levitop Comfort eFlow

Patient Lifts

Mobile patient lifts are designed to lift one person at a time, allowing caregivers to perform safe and comfortable transfers for both the user and the caregiver. They can be used to lift from or to a wheelchair, toilet, bathtub or shower, stretcher, or bed (including directly from or to the floor) with the use of an appropriate sling.

The devices are used to move people over short distances within a room or within a patient's activity area. Movement is permitted only on horizontal, flat surfaces and within a single floor of the building. If transportation on flat, sloping surfaces is necessary, an additional person is recommended to ensure the patient's safety. Lifts must only be used for individuals whose weight does not exceed the maximum lifting capacity of the lift and its slings.

Thanks to high-quality Linak batteries, the devices can operate for many hours without being connected to a power supply.

Patient lifts are extremely useful in hospitals, nursing homes, and residential medical care facilities.



VertiUp



VertiUp Plus



VertiUp Plus eFlow



Verteo

Choosing the proper lift can seem like a difficult task, so we will try to make it easier for you. It is important to select a model that meets the individual needs of the user and the preferences of the caregiver.

How to choose the right lift? What should you pay attention to?

Below are some of the most important factors to consider:

- **User's physical fitness level** - If the person has difficulty standing up from a seated position independently but can control their upper body, a sit-to-stand lift is recommended. For individuals who have temporarily or permanently lost such control, a lift that allows full suspension is necessary.
- **User's weight** - Weight significantly affects the choice of a lift with the appropriate lifting capacity. Choosing incorrectly can compromise safety and damage the equipment. Some of our lifts are designed for users weighing up to 160 kg (e.g., Lifteo), while our VertiUp models can safely accommodate individuals weighing up to 310 kg.
- **Range of mobility** - If the lift will only be used for transfers within a short distance, such as from a bed to a wheelchair, stationary lifts will suffice. However, when more movement within a room or transfer between rooms is required, a mobile lift with wheels is a better option.
- **Room size** - For small rooms with narrow doorways, we recommend a compact, highly maneuverable lift. If the device will be used in spacious rooms where movement is unrestricted, a larger unit is preferable. These models are most often chosen by caregivers working in medical facilities, rehabilitation centers, and nursing homes.
- **Type of operation (electric or mechanical)** - Electric lifts do not require physical effort during use; they are operated with a remote control.

Meden-Inmed's Lifts advantages

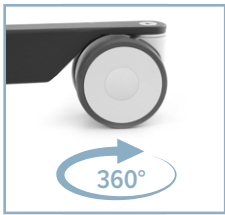

Smooth mobility

Double front castors provide easy turning.



Ergonomic grip handles

Large, easy to grip, facilitate maneuverability.



Comfortable Use

Low base and adjustable leg span
Allows easy access to wheelchairs, beds, and other furniture.



Robust castors

The lifts are fitted with high-quality castors from the renowned company TENTE. Rear castors feature brakes that prevent unintended movement, ensuring stability when the operator is positioning the user on the lift.



Safe to use

Equipped with an emergency stop button for added safety.



Battery powered

The battery is quick and easy to replace, minimizing downtime.



Easy charging

Standard internal charger included, with optional wall charger available.



Emergency lowering

The lever enables safe, mechanical lowering of the user - for example, in the event of battery discharge.



Easy operating

360° rotating hanger bar for smooth maneuverability.



High lift capacity

Max. patient's weight up to 310 kg.



Compact dimensions

The lift can be folded down for easy storage (PatiHoist, Lifteo ELA).



Usage safety

The hanger bar lock prevents unintended movement while the patient is suspended.



Convenient position adjustment

Special types of hanger bars equipped with electric actuators.



Wide lifting range

Allows lifting the user even from floor level.



Reliable actuators

The lifts are equipped with actuators from the prestigious company Linak (in the PatiHoist model, Jiechang actuators are used).



Smooth lifting / lowering

Electric actuators provide uniform, shock-free lift arm movement.



Remote control

Easy, intuitive operation via remote control.

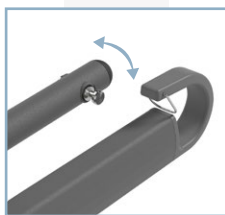

Compatible with various sling types

Multiple sling attachment options expand the range of compatible patient slings. Depending on the patient's weight and size, the clip sling can be mounted either on the outside or inside.

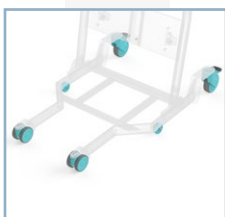

Great stability

The base is thoughtfully designed to ensure durability and stable operation.



High quality

The lifts are made of steel powder coated elements with great attention to detail.

Patient lift PatiHoist



Max. lifting capacity



Mechanical base leg spread



Compatible hanger bar:

- 2P45 - fixed*, 2-point
- 4PSB ALU - fixed*, 4-point

PatiHoist



See more:
www.meden.link/PatiHoist-vEN

The **PatiHoist** is an easy-to-use, compact patient lift designed for the full-body suspension of immobilized individuals. Its small size and excellent maneuverability make it ideal for use in smaller rooms where space is limited.

One of its key advantages is the ability to fold the lift for convenient storage. Its relatively low weight and compact folded size allow it to fit into a car trunk, making transportation to remote locations simple when needed. A large-capacity battery supports dozens of lifting and lowering cycles on a single charge, reducing the need for frequent recharging.

These features make PatiHoist an excellent choice for home care, nursing facilities, and similar environments.

* Fixed hanger bars without inclination adjustment.

** Folding function available only with 2-point fixed hanger bars.



Large-capacity battery

Supports extended operation before recharging is required.

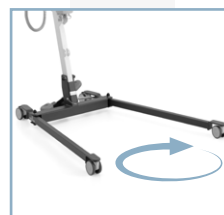

Small turning radius

Easy maneuvering in tight or confined spaces.



Compact dimensions

Folds for convenient storage (available on models with 2-point hanger bars only).



Scale (optional)

Mobile patient lift Lifteo ELA



Lifteo
ELA

Max. lifting capacity

Electrical base leg spread

Compatible hanger bars (SWL 160 kg):

- 2P35 – fixed, 2-point, L= 35 cm
- 2P45 – fixed, 2-point, L= 45 cm
- 2P60 - fixed, 2-point, L= 60 cm
- 4PSB - fixed, 4-point

Compatible hanger bar (SWL 120 kg):

- 4ESB-S - electric, 4-point

See more:
www.meden.link/Lifteo-vEN

Simple-to-operate lift, designed for end-users with a maximum weight of 160 kg. The mobile patient lift Lifteo ELA is available with a choice of five hanger bars.

It features electrical adjustment of the base leg spread and supports fixed, manual, or electric hanger bars (2P35, 2P45, 2P60, 4PSB or 4ESB-S).

A key advantage of Lifteo* is its folding capability, which facilitates easy storage. The lift is distinguished by a wide range of compatible hanger bars. The large battery allows for approximately 35 complete lifting and lowering cycles on a single charge (at maximum load of 160 kg).



Ergonomic handles



Compact dimensions
Folds for convenient storage (available on models with 2-point hanger bars only).

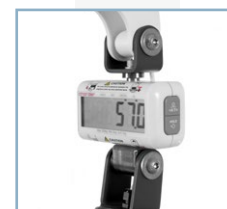

Scale (optional)

* Only in models with fixed, 2-point hanger bars.

Mobile patient lift

Levitop Standard/Comfort

Patient lift with a reinforced construction, designed for daily care of users weighing up to 230 kg.

Thanks to its features, it is suitable for hospital wards, rehabilitation centers, nursing homes, and home care settings.

Mobile patient lift Levitop is available in two versions (both with electrical adjustment of the base leg spreading):

Levitop Standard – lift with a fixed hanger bar.

Levitop Comfort – lift with electric hanger bar.

The large-capacity battery enables approximately 20 complete lifting and lowering cycles on a single charge (with a maximum load of 230 kg).



Max. safe working load (SWL)



Levitop Standard



Electrical base leg spread



Compatible hanger bars:

- 4PSB - fixed, 4-point
- 4PSB ALU - fixed, 4-point
- 2P35 – fixed, 2-point, L= 35 cm
- 2P45 – fixed, 2-point, L= 45 cm
- 2P60 - fixed, 2-point, L= 60 cm



See more:

www.meden.link/Levitop-Standard-vEN



Smooth inclination adjustment of the 4ESB-A hanger bar (via remote-controlled actuator) allows positioning the user in the most comfortable and safe manner.



Levitop Comfort



Electrical base leg spread



Compatible hanger bars:

- 4ESB-A - electric, 4-point



See more:

www.meden.link/Levitop-Comfort-vEN



Scale (optional)

Mobile lift

VertiUp/VertiUp Plus

This type of lift is designed for vertical lifting (lowering) of end-users with limited mobility. It combines the advantages of an electrically adjustable sling bar with the precision and power of vertical lifting, making it highly versatile and suitable for a wide range of applications. The very large arm movement range allows for easy lifting from a bathtub, wheelchair, or even the floor, and safe transfers to the bathroom, toilet, or a high bed - all while maintaining a comfortable, smoothly adjustable position. Especially recommended for the care of overweight or obese individuals (up to 310 kg).

Available in two versions (both with electrical base leg spread adjustment):

VertiUp - with a maximum load of 250 kg

VertiUp Plus - with a maximum load of 310 kg



Recommended for overweight and obese patients



Electrical base leg spread

Average number of cycles per full battery charge: 11.

A universal solution for hospitals, rehabilitation centers, and nursing homes.



4ESB-A

VertiUp



4ESB-O

VertiUp Plus



Max. safe working load (SWL)



Compatible hanger bars:

- 4ESB-A - electric, 4-point
- 4ESB-O - electric, 4-point (only up to 250 kg)

Inclination angle (up/down) 4ESB-A/4ESB-O [°]: -17/+42 / -17/+42

Turning diameter 4ESB-A/4ESB-O [cm]: 79 / 86



Max. safe working load (SWL)



Compatible hanger bar:

- 4ESB-O - electric, 4-point

Inclination angle (up/down) [°]: -17 / +42

Turning diameter: 86



See more:

www.meden.link/Vertiup-vEN



Wide lifting range

Allows lifting the user even from floor level.



User comfort

Smooth adjustment ensures optimal positioning.



Easy operation

Via remote control or built-in keyboard.



Patient weight trend tracking module

Optional feature available for VertiUp / VertiUp Plus.

Mobile patient lift

Levitop Standard eFlow/ Comfort eFlow

Introducing Levitop Comfort eFlow and Standard eFlow, patient lifts that improve daily patient care. This solution increases comfort and safety for both patient and caregiver.

The Levitop eFlow is equipped with an assistance system that supports lift movement - making it easy to guide, rotate, and turn the lift with minimal operator effort.

A safe, comfortable, and easy-to-use device that makes moving easier than ever before, Levitop eFlow transforms the quality of patient care. The assistance system used allows for safer operation and prevents physical strain on the lift operator.



Max. safe working load (SWL)

eFlow The eFlow assistance system (drive system)



4PSB ALU
Levitop
Standard
eFlow



Levitop
Comfort
eFlow



Compatible hanger bars:

- 4PSB ALU - fixed, 4-point
- 4PSB - fixed, 4-point



Compatible hanger bars:

- 4ESB-A - electric, 4-point



See more:

www.meden.link/Levitop-eFlow-vEN

The eFlow assistance system (drive system). It consists of two main parts: the drive system and the steering handle. The drive wheel is located between the two castors at the bottom of the lift. The steering handle mimics the operator's movements thanks to built-in sensors. The drive system, powered by LINAK's lithium-ion battery, drives the lift with minimal effort. The drive system allows the lift to be moved in any direction with minimal effort. As a result, control of the lift is intuitive and independent of the weight of the patient and the lift itself.

Very sensitive sensors ensure that the lift moves smoothly and is easy to manoeuvre in tight spaces. If the hand is removed from the handle (control rail), the built-in electromagnetic brake stops the unit in a short time.



Scale
(optional)



Steering
handle



Drive
system

Mobile lift

VertiUp eFlow/ VertiUp Plus eFlow

The VertiUp eFlow is a battery-powered medical device. Thanks to the electric drive, the lift is easy and light to control, regardless of the patient's weight. The movement of the device is smooth thanks to the use of sensors hidden in the handle, thus making the manoeuvring of the lift simple and intuitive. The functions of the lift, such as the movement of the arm, hanger bar, or legs, can be controlled by a remote control or a control panel. The lifting movement is vertical.

The VertiUp eFlow is designed for use in hospitals, sanatoriums, and care facilities. It is used to assist with the transfer and repositioning of people who have reduced mobility as a result of illness or dysfunction. Using a suitable suspension, it can be used to lift a patient directly from the floor to or from a wheelchair, toilet, bath or shower tray, or bed.



eFlow The eFlow assistance system (drive system)



VertiUp
eFlow



Max. safe working load (SWL)



Compatible hanger bars:

- 4ESB-A - electric, 4-point
- 4ESB-O - electric, 4-point (only up to 250 kg)

Inclination angle (up/down) 4ESB-A/4ESB-O [°]: -17/+42 / -17/+42

Turning diameter 4ESB-A/4ESB-O [cm]: 79 / 86



See more:

www.meden.link/VertiUp-eFlow-vEN



VertiUp
Plus eFlow



Max. safe working load (SWL)



Compatible hanger bar:

- 4ESB-O - electric, 4-point





Inclination angle (up/down) [°]: -17 / +42

Turning diameter [cm]: 86



Patient weight trend tracking module (optional)

Comparison of the most important technical data

	PatiHoist	Lifteo ELA	Levitop	
			Standard	Comfort
 Base legs spreading:	mechanical	electrical	electrical	electrical
 Max. safe working load (SWL) [kg]:	160	160 (120)*	230	230
 Length [cm]:	127	128	130	130
 Width [cm]:	62	61	67	67
 Height [cm]:	134	136	135	135
 Lifting range (CSP**) [cm]:	71 - 192	72 - 194	68 - 196	68 - 196
 Min. turning diameter [cm]:	138	140	144	144
 Min. base legs width (int./ext.) [cm]:	45 / 62	49 / 61	52 / 67	52 / 67
 Max. base legs width (int./ext.) [cm]:	80 / 94	100 / 112	103 / 118	103 / 118
 Base legs height [cm]:	9,5	9,5	11,5	11,5
 Wheels diameter (without / with lock) [cm]:	7,5 / 7,5	7,5 / 10	10 / 12,5	10 / 12,5
 Weight [kg]:	39	45	61	66
 Battery capacity [Ah]:	2,2	2,9	2,9	2,9
 Charger (integrated with control box) [V/Hz]:	110-240 / 50-60 (no integrated)	100-240 / 50-60	100-240 / 50-60	100-240 / 50-60
 Remote control functions***	<ul style="list-style-type: none"> • up/down • overload indicator • battery charge status 	<ul style="list-style-type: none"> • up/down • el. leg spread: outside/inside • battery charge status • service indicator • overload indicator 	<ul style="list-style-type: none"> • up/down • el. leg spread: outside/inside • battery charge status • service indicator • overload indicator 	<ul style="list-style-type: none"> • up/down • hanger bar forward/backward tilt • el. leg spread: outside/inside • battery charge status • service indicator • overload indicator
 Protection level (control box):	IPX54	IPX4	IPX6W	IPX6W
 Packed dimensions (LxWxH) [cm]:	140 x 80 x 60	140 x 80 x 60 (with 2-point hanger bar) 150 x 80 x 155	140 x 80 x 155	140 x 80 x 155
 Packed weight [kg]:	55 (with 2P45 hanger bar)	55 (with 2P45 hanger bar)	95	95

* Applies to Lifteo ELA with 4ESB-S hanger bar.

** CSP - Central sling point - hanger bar (only in case of VertiUp / VertiUp eFlow / VertiUp Plus / VertiUp Plus eFlow); in others lifts the measure point is the end of the arm.

*** Also functions on built-in keyboard in case of VertiUp / VertiUp eFlow / VertiUp Plus / VertiUp Plus eFlow.

Levitop		VertiUp	VertiUp Plus	VertiUp eFlow	VertiUp Plus eFlow
Standard eFlow	Comfort eFlow				
electrical	electrical	electrical	electrical	electrical	electrical
230	230	250	310	250	310
152	152	135	144	140	148
67	67	68	78	68	78
135	135	min. 188 max. 226	min. 188 max. 226	min. 188 max. 226	min. 188 max. 226
68 - 196	68 - 196	35 - 173	33 - 171	35 - 173	33 - 171
144	144	170	184	170	184
52 / 67	52 / 67	53,5 / 68	64 / 78	53,5 / 68	64 / 78
103 / 118	103 / 118	126 / 141	144 / 155	126 / 141	144 / 155
11,5	11,5	11,5	7,5	11,5	7,5
10 / 12,5	10 / 12,5	10 / 12,5	5,0 / 12,5	10 / 12,5	5,0 / 12,5
76	81	87,7	97,6	103	113
2,9	2,9	2,85	2,85	2,85	2,85
100-240 / 50-60	100-240 / 50-60	100-240 / 50-60	100-240 / 50-60	100-240 / 50-60	100-240 / 50-60
<ul style="list-style-type: none"> • up/down • el. leg spread: outside/inside • battery charge status • service indicator • overload indicator 	<ul style="list-style-type: none"> • up/down • hanger bar forward/backward tilt • el. leg spread: outside/inside • battery charge status • service indicator • overload indicator 	<ul style="list-style-type: none"> • up/down • hanger bar forward/backward • el. leg spread: outside/inside 	<ul style="list-style-type: none"> • up/down • hanger bar forward/backward • el. leg spread: outside/inside 	<ul style="list-style-type: none"> • up/down • hanger bar forward/backward • el. leg spread: outside/inside 	<ul style="list-style-type: none"> • up/down • hanger bar forward/backward • el. leg spread: outside/inside
IPX6W	IPX6W	IPX6	IPX6	IPX6	IPX6
160 x 85 x 155	160 x 85 x 155	150 x 85 x 212	150 x 85 x 212	160 x 85 x 212	160 x 85 x 212
105	105	115	115	125	125

Compatible: Hanger bars



		PatiHoist	Lifteo ELA	Levitop		VertiUp/ VertiUp eFlow	VertiUp Plus/ VertiUp Plus eFlow
				Standard/ Standard eFlow	Comfort/ Comfort eFlow		
	2P35 fixed (*), 2-point, L= 35 cm for loop slings		✓	✓ (Standard only)			
	2P45 fixed (*), 2-point, L= 45 cm for loop slings	✓	✓	✓ (Standard only)			
	2P60 fixed (*), 2-point, L= 60 cm for loop slings		✓	✓ (Standard only)			
	4PSB fixed (*), 4-point for loop slings		✓	✓			
	4PSB ALU fixed (*), 4-point for loop slings	✓		✓			
	4ESB-A electric (**), 4-point for clip slings				✓		
	4ESB-A (ver. VertiUp) electric (**), 4-point, up to 250 kg, for clip slings					✓	
	4ESB-S electric (**), 4-point, up to 120 kg, for clip slings		✓				
	4ESB-O electric (**), 4-point, up to 310 kg, for clip slings					✓ (up to 250 kg)	✓

* Without possibility of inclination adjustment.

** With possibility of inclination adjustment (electrical).

Additional accessories:

Slings



High Easy Sling
Model HY(SIZE)CP:

- fabric: polyester or polyester mesh,
- size: M, L, XL,
- load: max. 220 kg (SWL)
- fastening: clips.



Rigid Stand Aid Sling
Model DA-AS112:

- fabric: polyester,
- size: M, L, XL,
- load: max. 220 kg (SWL),
- fastening: clips.



Fastfit Padded Leg HS
Model S2HS:

- fabric: polyester or polyester mesh,
- size: M, L, XL,
- load: max. 220 kg (SWL),
- fastening: loops.



Stretcher Sling
Model 033B:

- fabric: polyester mesh,
- size: S, M, L,
- load: max. 220 kg (SWL),
- fastening: loops.

[See other types of slings in the Slings Catalogue](#)

Sit-to-stand lift Verteo



Max. safe working load (SWL)



Electrical base leg spread



See more:
www.meden.link/Verteo-vEN

Verteo

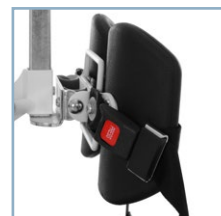

Tibial support

Adjustable; supports patient's legs in the tibial area.



Solid sling attachment

Lifting arm with 4 pins for easy clip sling fastening.



Stable footplate

Comfortable feet support.

Sit-to-stand lift VERTEO is designed for end-user with low core stability, who have difficulty standing up on their own from a seated position and is used to transfer a patient between seated surfaces.

Built to support the upper body part, so requires the ability to support the majority of end-user weight while standing and to control her / his upper body and head. The user is lifted up step by step to upright position, while both feet remain on a secure platform and shanks are placed against special pads. It raises the user to a partial or full standing position.

This type of lift encourages a natural standing / sitting motion and is ideal during everyday activities, e.g. getting up / getting out of bed, getting out of chair, using the toilet, etc. This lift can be used in hospitals, nursing homes, other care facilities.



Mobile patient lift VertiHelp / VertiHelp UNI / VertiHelp UNI eFlow

VertiHelp is a compact mobile device ideal for people who experience difficulty walking but who can sit and stand with support. It is used to transfer the user between seated positions, such as moving to or from an armchair, chair, wheelchair, bed, or toilet.

This device facilitates movement during dressing changes, hygiene, and other care activities.

Ideal for daily use in nursing homes, hospitals, sanatoriums, and home care settings, its small turning radius makes it suitable even for confined spaces. As a non-powered device, VertiHelp simplifies everyday transfers with ease.

Foot lever enables easy adjustment of the base leg spread. Combined with the low footrest, it allows easy access to wheelchairs, beds, and more.



Features of VertiHelp / VertiHelp Uni / VertiHelp UNI eFlow:



2 large handles

For the personnel (assistant) to maneuver the device, and a user handle for the end-user to hold onto when entering the lift or during transfer.



Adjustable knee pad

It provides support for raising the patient into a half-standing position and supports the legs during transfer.



Rear castors with lock

Prevent unintentional movement, for example, while the end-user is sitting down.

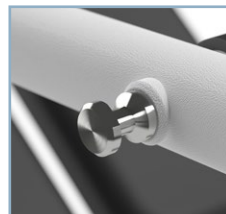

Hook (optional)

On both sides - for mounting the patient's safety belt (with clips).



Seat parts

Rotate sideways to make it easier for end-user to get into position.



See more:

www.meden.link/VertiHelp-vEN

Mobile patient lift

VertiHelp / VertiHelp UNI / VertiHelp UNI eFlow



VertiHelp



KG
180

Max. safe working load (SWL)

Key features of VertiHelp:

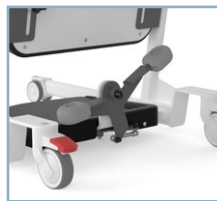

Foot lever

Easily adjusts the base leg spread. Combined with the low footrest, this allows effortless access to wheelchairs, beds, and more.



Base legs spreading

Ranges from 50 to 91 cm to accommodate various environments.



Available and ready

Fully assembled upon unpacking - no installation required.

VertiHelp UNI



KG
180

Max. safe working load (SWL)

Key features of VertiHelp UNI:



Small transport dimensions

Shipped partially disassembled (upper section and footrest separate) in a small carton for space-saving transport.

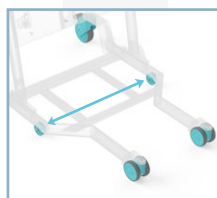

Additional wheels

Two extra wheels enhance overall device and patient stability.



Narrowed part of base legs

Reduced distance between the legs simplifies access to seating with tight clearances.

VertiHelp

UNI eFlow



KG
180

Max. safe working load (SWL)

eFlow The eFlow assistance system (drive system)



eFlow drive module
Drive module with a motorized wheel.

Key features of VertiHelp UNI eFlow:



Hand control

Electric steering of the motorized wheel (forward/backward).

Magnetic mount for hand control

Secures the hand control to the handle - allowing you to operate the eFlow drive without removing your hands, maintaining full control of direction and speed.

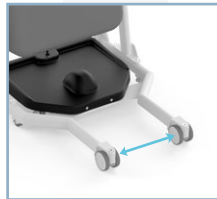

Narrowed part of base legs

Reduced distance between the legs simplifies access to seating with tight clearances.

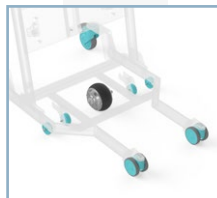

Additional wheels

Four extra wheels enhance device and patient stability.



Compact transport dimensions

Delivered in a partially disassembled form (upper section and footrest separate) in a small carton to minimize transport volume.

Additional accessories:

Belt:



standard







with additional support

Two types of stabilization belts available: a standard version and one with additional support. Both attach to side-mounted pins.

Available in two sizes: S/M or L/XL.



Comparison of the most important technical data

	Verteo	VertiHelp	VertiHelp UNI	VertiHelp UNI eFlow
 Base legs spreading:	electrical	mechanical	-	-
 Max. safe working load (SWL) [kg]:	230	180	180	180
 Dimensions (L x W x H) [cm]:	108 x 75 x 113	90,5 x 63 x 102	95 x 62,2 x 102	95 x 62,2 x 102
 Raising range [cm]:	78 - 174	-	-	-
 Seat height [cm]:	-	80,7	80,7	80,7
 Total seat width [cm]:	-	45	45	45
 Seat inclination angle [°]:	-	38	38	38
 Tibial support (mounted downwards) height (min./max.) [cm]:	39 / 52	-	-	-
 Tibial support (mounted upwards) height (min./max.) [cm]:	53 / 66	-	-	-
 Knee pad height adjustment (min./max.) [cm]:	-	43 / 51,5	43 / 51,5	43 / 51,5
 Knee pad inclination [°]:	-	100	100	100
 Min. base legs width (int./ext.) [cm]:	51 / 66	50 / 62	-	-
 Max. base legs width (int./ext.) [cm]:	101 / 115	91 / 103	-	-
 Fixed base legs (narrowed part) width (int./ext.) [cm]:	-	-	26 / 38	26 / 38
 Base legs height [cm]:	11,5	7,5	7,5	7,5
 Castors diameter (without / with lock) [cm]:	10 / 12,5	7,5 / 10	7,5 / 10	7,5 / 10
 Weight [kg]:	60	35,5	33,5	42
 Battery capacity [Ah]:	2,9	-	-	3.8 (LiFePO4)
 Min. turning diameter [cm]:	124	120	106,7	106,7
 Charger (integrated with control box) [V/Hz]:	100-240 / 50/60	-	-	100-240 / 50/60
 Remote control functions:	<ul style="list-style-type: none"> • up/down • el. leg spread outside/ inside • battery charge status • service indicator • overload indicator 	-	-	forward/backward
 Packed dimensions (L x W x H) [cm]:	120 x 80 x 150	105 x 97,5 x 150	94 x 70 x 52	94 x 70 x 52
 Packed weight [kg]:	90	70	43	51,5

Mobile assistive product VertiAID / VertiAID UNI



KG 170 Max. safe working load (SWL)

The VertiAID / VertiAID UNI is a manual, mobile assistive device designed to support caregivers in their daily tasks. It enables safe, upright transfers by allowing the device to be pushed, pulled, and rotated with minimal effort.

Ideal for moving users between chairs, wheelchairs, beds, and toilets, it ensures a secure transfer for the user and a safe working environment for healthcare personnel. It's particularly beneficial for patients who can stand with some independence or minimal assistance—such as those experiencing pain, limited joint mobility, stiffness, or muscle weakness.

The device is intended for use in hospitals and other healthcare facilities, health resorts, nursing homes, and private home care.

VertiAID



VertiAID UNI



Low footrest (height only 4 cm)

At just 4 cm high, the narrow yet stable footrest (35.5 cm wide) allows for easy and secure foot placement - ideal for positioning close to a wheelchair.

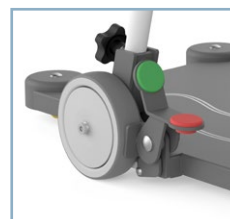

Stability

Brakes lock securely during sit-to-stand transfers, while the footrest offers dependable support for the user's feet, minimizing slip risk.



Curved handles (3 levels)

Ensure a secure grip for patients and caregivers of varying heights. They also function as a support "ladder," aiding users as they stand or sit.



Clear Markings

Clear indicators show safe and stable position for the patient's feet.



Foam knee pad

PU-upholstered foam knee pads support the lower legs during transfers (e.g., from chair to device) and throughout transportation.



Maneuverable

Thanks to the 2 large wheels (Ø 12.5 cm) and 4 small wheels (Ø 3.5 cm), the device maneuvers easily, even through narrow spaces.

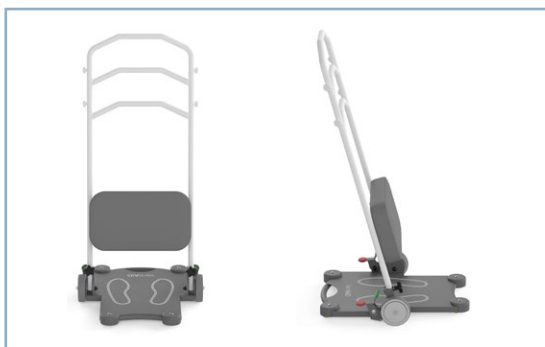

Functionality

Its slim profile fits through most standard doorways, increasing versatility across care environments.

Inclination Angle

A 74° forward tilt ensures optimal patient positioning with minimal effort.

Additional accessories:

Belt:













standard



with additional support



Two types of stabilization belts available: a standard version and one with additional support. Both attach to side-mounted pins.

Available in two sizes: S/M or L/XL.

	VertiAid	VertiAid Uni
 Length [cm]:	63	63
 Height [cm]:	116	116
 Width [cm]:	57	57
 Height of the top edge of knee pad (min. / max.) [cm]:	40 / 63	45 / 54
 Knee pad dimension (W x H) [cm]:	45,5 x 26,5	45,5 x 26,5
 Inclination angle of the handle to the footrest [°]:	74	74
 Turning diameter [cm]:	75,1	75,1
 Max. user weight [kg]:	≤ 170	≤ 170
 Weight [kg]:	20,5	18,5
 Weight with packing [kg]:	21,5	19,5

Both devices are foldable for transport.

The upper part and footrest are delivered separately, packaged in cardboard.

	VertiAid	VertiAid Uni
knee pad	8-stepwise smooth height adjustment 8 levels, in range: 40-63 cm, profiled knee pad 	fixed knee pad with the possibility of reposition (at 3 levels: 45, 49,5 or 54 cm), flat knee pad 
	optional: flat knee pad instead of profiled knee pad 	optional: profiled knee pad instead of flat knee pad 
brakes	central brake system: operates on both wheels simultaneously 	individual brakes (left, right): brakes can be operated separately 
	optional: individual brakes (left, right): brakes can be operated separately instead of central brake system 	optional: central brake system: operates on both wheels simultaneously instead of individual brakes (left, right) 

Commode / shower chair

MoHiCan II, MoHiCan II PLUS



The **MoHiCan II**, **MoHiCan II PLUS** commode/shower chairs are designed to assist individuals with physical disabilities during transfers and daily care activities. The chair allows caregivers to adjust both the height and tilt of the seat, enabling the user to remain in a stable and comfortable position for extended periods. Constructed from welded, powder-coated stainless steel sections, the device ensures durability and hygiene. The MoHiCan chairs are intended for use in private homes, hospitals, sanatoriums, nursing homes, and other care facilities. The user should only be moved on horizontal, flat surfaces and within a single floor of the building. If transportation over flat, inclined surfaces is required, assistance from an additional person is recommended.

With the included remote control, MoHiCan II chairs allow effortless adjustment of height and seat inclination (forward and backward tilt). The chair is easy to maneuver and can be positioned directly over a toilet for convenience.



Max. safe working load (SWL)



See more:
www.meden.link/MoHiCan-II-vEN



MoHiCan II PLUS

MoHiCan II



Tilt and height seat adjustment
Electrically adjustable for user and caregiver comfort.

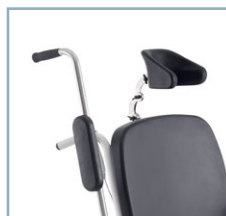

Armrests
Comfortable arm support; can be lifted up for easy access to the user.

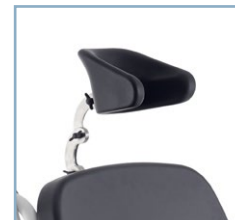

Head support
Flexible and fully adjustable to ensure maximum comfort for the user.



Removable battery
Easy to recharge.





















Remote control
Functions: raising/lowering seat, forward / backward tilt (seat).



Footboard
Foldable, adjustable, large foot support.

4 castors with brake

Comparison of the most important technical data

	MoHiCan II	MoHiCan II PLUS
 Max. safe working load (SWL) [kg]:	180	250
 Length [cm]:	89	89
 Width [cm]:	65,8	77,8
 Handles height (min. / max) [cm]:	102,8 / 126	102,8 / 126
 Lifting range [cm]:	49,5 - 101	49,5 - 101
 Seat dimensions [cm]:	54 x 41,8	57 x 41,8
 Turning diameter [cm]:	110	120
 Tilt adjustment [°]:	-5 to + 27	-5 to + 27
 Footboard height [min.]:	11,2	11,2
 Castors diameter [cm]:	12,5	12,5
 Weight [kg]:	60	70
 Battery capacity [Ah]:	2,9	2,9
 Charger (integrated with control box) [V / Hz]:	100-240 / 50 / 60	100-240 / 50 / 60
 Protection level of control panel	IPX6	IPX6
 Space between armrest's pads [cm]:	51,5	58,9
 Lifting speed (0 / max.load) [s:]	raising	42 / 49
	lowering	47 / 41
 Packed dimensions (L x W x H) [cm]:	100 x 71 x 123	100 x 85 x 122
 Packed weight [kg]:	76	90

Additional accessories:



Toilet bowl
Easily removable, for hygiene and sanitary purposes.



Torso belt
Provides secure stabilization for the user during transfers or positioning.



Leg belt
Ensures secure stabilization of the legs during transfers or positioning.

Bathtub hoist Hydraid



Hydraid (when seated)

The Hydraid bathtub hoist, equipped with height adjustment, is designed for use in hospitals, sanatoriums, and nursing homes. It is intended for lifting, transferring, and bathing individuals with reduced mobility due to illness or disability, enabling the caregiver to move the patient directly from the bed to the bathtub and back again.

The device can be operated by a single person, ensuring ergonomic working conditions for caregivers. It is available with or without a patient weight trend tracking module.

The Hydraid hoist can be used together with the Bathaid care bathtub for comprehensive patient care.



Vertical lifting/ lowering

Via control panel
or manual remote
control.



+
Compact,
robust design
(when seated)



→
Lying option
2 special parts attached
on standard hoist create
3-part lying top + pillow.



**Hydraid
(when lying)**
Combination
of lying top
positions to suit
various patient
needs.



Max. safe working load (SWL)



See more:

www.meden.link/Hydraid-vEN

Technical data:



Dimensions (when seated) (L x W x H (min./max.)) [cm]: 97 x 76 x 124/184



Dimensions (when lying) (L x W x H (min./max.)) [cm]: 97 x 184 x 124/184



Lying surface dimensions (L x W) [cm]: 43 x 184



Seat width [cm]: 43,5



Grip height [cm]: 119



Turning diameter [cm]: 115



Wheels diameter (with/without brake) [cm]: 12,5/10



Input voltage [V, Hz]: 100-240, 50-60



Battery capacity [Ah]: 2,9



Device weight [kg]: 95



Max. safe working load when lying/seated [kg]: 160/180



Lifting/lowering time [s]: 42/35

Models of charging stations



In our portfolio, we offer a range of patient-care equipment, each featuring one of several specialized controllers - each with its own dedicated charger. Over time, both controllers and chargers have evolved within the same device models and vary between product families. To avoid confusion, the following table provides a clear overview of charger types used across our equipment.

Alongside the LINAK controller COL50 has also been implemented a lithium-ion battery, which offers higher performance, longer service life, and reduced charging time compared to the previously used batteries.

Charging station models – refer to the images below for identification



JIECANG*
01-KPRX0105-003



LINAK CBJC*
01-KPRX0105-001









LINAK LIFT40*
01-KPRX0105-002



LINAK LIFT50*
01-KPRX0105-004

* to order as additional accessories

Device name	Type of charger*			Lithium-ion battery with COL50 controller
 <p>Mohican II, Mohican II Plus</p>	<p>Mohican II on LINAK CBJC until Q2 2023</p> <p>Charging station LINAK CBJC</p>	<p>Mohican II, Mohican II Plus on LINAK LIFT40 from Q3 2023</p> <p>Charging station LINAK LIFT40</p>	<p>Mohican II, Mohican II Plus on LINAK LIFT50 from Q1 2025</p> <p>Charging station LINAK LIFT50</p>	<p>✓</p>
 <p>PatiHoist</p>	<p>PatiHoist on JIECANG from Q3 2022</p> <p>Charging station JIECANG</p>			<p>-</p>

Device name	Type of charger*		Lithium-ion battery with COL50 controller
 <p>Verteo</p>	Verteo on LINAK CBJC until Q1 2025 Charging station LINAK CBJC	Verteo on LINAK LIFT50 from Q3 2025 Charging station LINAK LIFT50	✓
 <p>Lifteo ELA</p>	Lifteo ELA still on LINAK CBJC Charging station LINAK CBJC	Lifteo ELA on LINAK LIFT50 Available soon	Available soon
 <p>Levitop**: Standard / Standard eFlow, Comfort / Comfort eFlow</p>	Levitop on LINAK CBJC until Q4 2024 Charging station LINAK CBJC	Levitop on LINAK LIFT50 from Q1 2025 Charging station LINAK LIFT50	✓
 <p>VertiUp**: VertiUp, VertiUp eFlow, VertiUp Plus, VertiUp Plus eFlow</p>	VertiUp on LINAK CBJC until Q1 2024 Charging station LINAK CBJC	VertiUp on LINAK LIFT50 from Q2 2024 Charging station LINAK LIFT50	✓
 <p>Hydraid</p>	Hydraid still on LINAK LIFT40 Charging station LINAK LIFT40	Hydraid on LINAK LIFT50 Available soon	Available soon

**Please note: Images illustrate examples of selected lift models. Not all models listed in the table are shown.

Care bathtub Bathaid

Specially designed and intended for use in hospitals, nursing homes and long-term care facilities, the Bathaid care bathtub is ideal for bathing and washing patients. The built-in height adjustment feature facilitates personnel to perform hygienic activities related to the daily care of the patient.

Bathaid is a tub designed for patients with reduced mobility due to injury, illness, or disability.



Max. safe working load (SWL)

Bathaid ECONOMY

















Bathaid PREMIUM/ PREMIUM Plus



	ECONOMY	PREMIUM	PREMIUM PLUS
Thermostatic mixer with manual water filling spout	S	-	-
Thermostatic faucet with separate outlet	-	S	S
Control panel with touch screen and colour display	-	S	S
Automatic bathtub filling	-	S	S
Water temperature (basin) indicating system	O	S	S
Water temperature (outlet) indicating system	-	S	S
AIR function (air nozzles)	-	-	S
AUDIO	-	O	O
CHROMO - 12 LED points	-	O	O
AROMA	-	-	O
Drain closing knob for water discharge	S	S	S
Fixed panel and a remote control	S	S	S
Shower head	S	S	S
Handles	S	S	S
High speed lifting/lowering actuator	O	S	S
Disinfecting system	O	O	O
Rechargeable battery for emergency lowering	O	O	O
Headrest	O	O	O
Leg support	O	O	O

S - standard O - option



	Length [cm]:	199
	Width [cm]:	80
	Height min. / max (basin edge) [cm]:	72-112
	Basin depth [cm]:	43
	Drain Ø [cm]:	5
	Overflow capacity [l]:	270
	Power supply [V, Hz]:	230, 50
	Device weight (ECONOMY / PREMIUM / PREMIUM Plus) [kg]:	210 / 230 / 252
	Max. patient weight [kg]:	185
	Max. filling time up to overflow (ECONOMY / PREMIUM) (at flow ~70l / min) [min]:	~16 / ~9,5
	Max. drainage time of the bathtub basin [min]:	~4
	Lifting/lowering time - low-speed actuators (ECONOMY) at SWL 400 kg [s]:	~ 50
	Lifting / lowering time - high-speed actuators (ECONOMY (option)/ PREMIUM / PREMIUM Plus) at SWL 400 kg [s]:	~ 30
	Min. water level for bathing (PREMIUM / PREMIUM Plus) [l]:	170
	Packed dimensions (LxWxH)[cm]:	220 x 100 x 85

Control and adjustment elements:



Bathaid
ECONOMY



Bathaid
PREMIUM/PREMIUM Plus

The Bathaid bathtub can be used together with the Hydraid bath hoist



Shower trolley

Hydrogo-E, Hydrogo-H

Hydrogo-E(-H) Shower Trolley facilitates daily hygiene and bathing procedures, as well as transfer of persons with reduced mobility due to illness or dysfunction. The Hydrogo allows for easy transport of the patient and adjustment of the lying surface height with a shower mattress, which simplifies caregivers' work and enhances patient comfort during hygiene routines. The Hydrogo shower trolley is designed to maintain proper hygiene for individuals who cannot independently use a standard bathtub or shower. The device is intended for use in hospitals, sanatoriums, nursing homes, and other care or healthcare facilities.



 Max. safe working load (SWL)

Hydrogo-E



Hydrogo-H

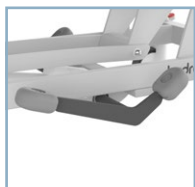

Foot pedal
Available at both sides of trolley (H-model).

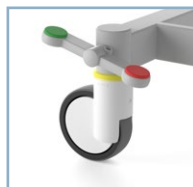

Brake lever
4 large castors of Ø12,5 cm.

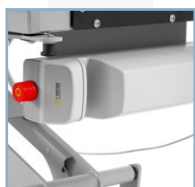

Control box with battery
Which controls the work of the actuator (E-model).



Hand control
(E-model).













Side rail
To prevent the patient from falling and support the shower mattress walls.

2 long foldable rails made of aluminium - only 2 kg (as option).



Surface tilt adjustment
Lever at both sides enables surface tilting of 4 degrees (this elevation corresponds to a water level drop of approx. 13,5 cm).

Technical data:	Hydrogo-E	Hydrogo-H
 Total dimensions (L x W) [cm]:	204 x 79	204 x 79
 Mattress dimensions (L x W) [cm]:	189 x 64	189 x 64
 Height adjustment (min. / max) [cm]:	48,6 / 96,6	48,6 / 96,6
 Weight [kg]:	107	107
 Surface tilt range [°]:	4	4
 Drain Ø [cm]:	5	5
 Electrical supply (battery) [V]:	24 V	-
 Applied part:	type B	-
 Protection level (control box/actuator):	IPX6 / IP54	-
 Packed dimensions (LxWxH) [cm]:	220 x 95 x 105	220 x 95 x 105
 Packed weight [kg]:	170	170

Patient transport table

Safari Buffalo E2.C4-H

Patient transport table Safari type Buffalo with a hydraulic actuator is designed for efficient transport in medical facilities. The table ensures easy operation for caregivers. The simple design provides reduced effort for medical personnel, improved quality of patient care and greater comfort for the patient.









Safari Buffalo E2.C4-H



 Max. lifting capacity

Technical data:

	Dimensions (L x W) [cm]:	228 x 80
	Number of sections:	2
	Head section inclination angle [°]:	0 / +70
	Length of head section [cm]:	69
	Height adjustment [cm]:	51 - 100
	Weight [kg]:	135

Accessories:



Handles for transport
On the head and leg sections.



Trendelenburg/ reverse Trendelenburg position (-10°/+10°) (option)

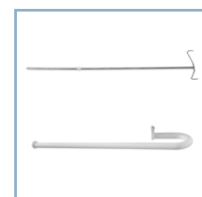

Drip hanger
Paper towel hanger
600 mm wide.

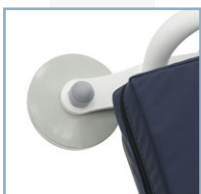

Bumpers at the corners

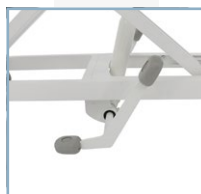

Foot pedals
On both sides of the trolley allow easy height adjustment (high/low).



Basket for clothes and personal items



Folding horizontal barriers
On both sides.



4 large (12,5 cm) TENTE noiseless castors (total lock)



Hanger for oxygen tank

Rehabilitation stool

DeMiro Spine Stool

The stool's ability to rotate 360° makes it easy to adapt to various working positions. Regular use promotes proper posture, which can help reduce discomfort associated with prolonged sitting.

The adjustable seat height allows precise positioning to achieve a 90-degree knee flexion angle - an important factor in maintaining correct posture, reducing spinal load, and minimizing the risk of hunching.

Seat adjustment by: foot position, chest position, rear screw.

DeMiro Spine Stool



Adjustment by means of rear screw*:

Loosen the rear screw to the desired position to allow the seat to tilt backwards.



*Special care should be taken when using the stool with the rear screw loosened. The manufacturer cannot be held responsible for the rapid lowering of the rear part of the seat when the upper body is tilted backwards, which can lead to a loss of balance and a fall from the stool. Tighten the rear screw as far as it will go to eliminate the risk of falling backwards.

LUX upholstery (standard), DIO7 upholstery (option).



Max. safe working load (SWL)



See more:

www.meden.link/DeMiro-Stool-vEN

Technical data:	large spring	small spring
Base width [cm]:	50	
Total height (min./max.) [cm]:	47,5 - 60,5	43,2 - 53,4
Seat dimensions (L x W) [cm]:	36 x 45	
Seat thickness [cm]:	5,5	
Seat inclination angle (up/down) [°]:	0 - 18	
Seat recess dimensions (L x W) [cm]:	17,8 x 17,4	
Height adjustment range [cm]:	13	
Diameter of foot with pin [cm]:	5	
Product weight [kg]:	10,5	
Weight of the product in the cardboard box [kg]:	13,3	
Packed dimensions (L x W x H) [cm]:	50,5 x 47,5 x 32,5	



Neurological walker with height adjustments

Freewalker

Freewalker is a height adjustable neurological walker.

It is designed to support the patient's rehabilitation, enabling the patient to move without the help of third parties. At the same time, it allows you to relieve the lower limbs by placing the upper limbs on upholstered supports and hand grips.

The device is intended for use in hospitals, sanatoriums, nursing homes and other healthcare facilities and for home use.

 **150 KG** Max. safe working load (SWL)

 See more:
www.meden.link/Freewalker-vEN

Technical data:

Height (min./max.) [cm]:	96,3 x 131,8
Dimensions (W x D) [cm]:	76 x 85,4
Max. safe working load of basket [kg]:	3
Max. safe load of hook [kg]:	3
Weight [kg]:	23,7



Additional accessories:



Adjustable upholstered armrests
With a range of 96,3 cm to 131,8 cm, easily adaptable to the patient's needs.



Solid construction
Made of welded steel pipes, powder-coated to increase durability of the finish.



Crutch holder



Mobility
4 wheels made of plastic and covered with nob-marking rubber (2 rear wheels with brake lock).



Rubber grips
providing a secure grip.



Basket



LEVITOP 230 kg



↑
MAXIMUM
HEIGHT