



A VOTRE SERVICE DEPUIS 1995

2026



EXPERIENCE

Over 20 years of market experience.

We operate in 57 countries.

Successful co-operation with numerous customers around the world.

ERFAHRUNG

Über 20 Jahre Markterfahrung.

Unsere Produkte machen Spaß in 52 Ländern.

Erfolgreiche Zusammenarbeit mit vielen Kunden aus der ganzen Welt.

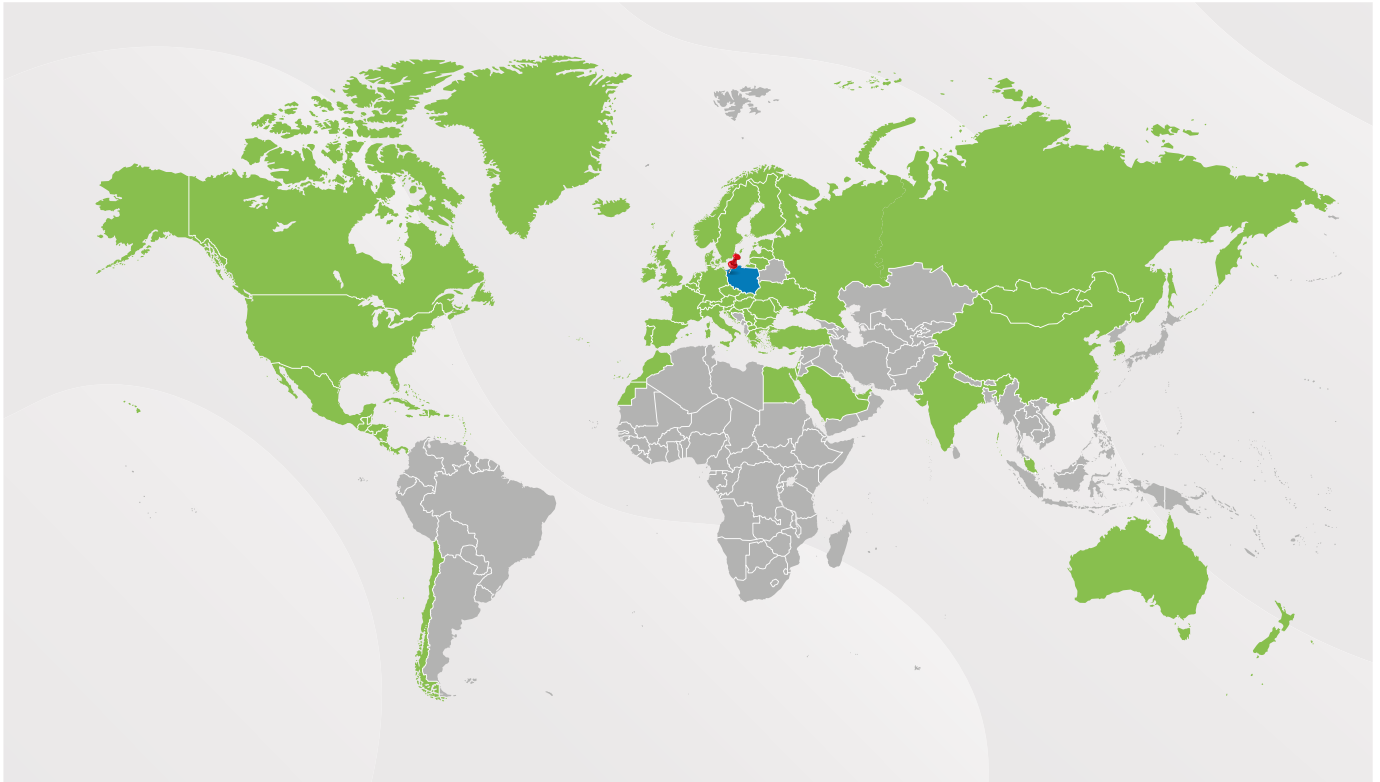

OFFER | ANGEBOT



SFERO
LIMAKO
LUMO PLAY
SALTO
INTEGRADO
LINARIUM
TRANSPORTO
MONTA
ROTO
PARK
AKRA
ROBINIA
DOG AGILITY



SPEED
FITNESS
STREET WORKOUT
NINJA PARK
ARENAS
OUTDOOR GAMES



COLLECTIONS
BENCHES
TRASH BINS
BICYCLE RACKS

Order our catalogue:



direction@healthsport.ch
sales@healthsport.ch

Sie können den Katalog in Papierform bestellen:

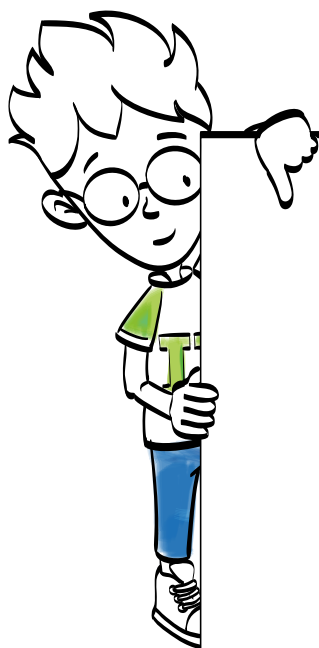
direction@healthsport.ch
sales@healthsport.ch



Please contact us:

-  direction@healthsport.ch
-  +41 21 903 57 67
-  <https://healthsport.ch/>

**Zögern Sie sich nicht,
uns zu kontaktieren:**

-  direction@healthsport.ch
-  +41 21 903 57 67
-  <https://healthsport.ch>

Inter Play Studio

Free online application to design your playground in minutes. Draw or set the size of your plot, drag-and-drop equipment, and preview the layout in 2D or 3D with automatic safety clearances.

Kostenlose Online-Anwendung, um Ihren Spielplatz in wenigen Minuten zu planen. Zeichnen oder definieren Sie die Größe Ihres Grundstücks, platzieren Sie Geräte per Drag-and-drop und sehen Sie die Anordnung in 2D oder 3D – mit automatischen Sicherheitsabständen.

1



Drag-and-drop equipment from our catalogue; filter by function, series, age group, landscape, or surface.

Drag-and-drop oder Belag. von Geräten aus unserem Katalog; Filter nach Funktion, Serie, Altersgruppe, Landschaft

2



Automatic safety zones generated from product specs to help meet standards.

Automatische Sicherheitsbereiche gemäß Produktspezifikationen – zur normgerechten Planung.

3



Save & share visuals for internal approvals and stakeholder presentations.

Speichern & teilen von Visualisierungen für interne Freigaben und Stakeholder-Präsentationen.

Prototype early. Test ideas before detailed design begins.

Früh prototypen. Ideen testen, bevor die Detailplanung startet.

Reduce rework. Safety clearances and space rules are visible from the start.

Nacharbeit reduzieren. Sicherheitsabstände und Flächenregeln sind von Anfang an sichtbar.



Choose smarter. Compare options, swap items, and refine the layout on the fly.

Klüger auswählen. Varianten vergleichen, Geräte tauschen und das Layout spontan verfeinern.



Try this tool on **interplay.eu**

Probieren Sie dieses Werkzeug aus **interplay-spiel.de**





„Now with AI image creation support“

„Jetzt mit Unterstützung von KI-Bilderstellung“

TRAMPOLINE DESIGN STUDIO

Create your unique design on the trampoline.
Based on your project, we will make a trampoline for you.

Erstellen Sie Ihr einzigartiges Design für das Trampolin. Basierend auf Ihrem Projekt werden wir ein Trampolin für Sie anfertigen.

1



Choose trampoline parameters (shape, size, collar color)

Wählen Sie die Trampolinparameter (Form, Größe, Farbe des Kragens)

2



Create a unique, custom trampoline design.

Erstellen Sie ein einzigartiges, individuelles Trampolin-Design.

3



Receive your design at the provided email address. You can order the trampoline production from us.

Erhalten Sie Ihr Design an die angegebene E-Mail-Adresse. Sie können bei uns die Herstellung des Trampolins bestellen.

Possibility to save the project file and return to work on it later.

Möglichkeit, die Projektdatei zu speichern und später weiter daran zu arbeiten.

Choose from various sizes and shapes of trampolines.

Wählen Sie aus verschiedenen Größen und Formen von Trampolinen.

The design of the trampoline is limited only by your imagination.

Das Trampolinmuster ist nur durch Ihre Vorstellungskraft begrenzt.

Wide selection of trampoline lamellas and collar colors.

Große Auswahl an Farben für Lamellen und Trampolinrand.

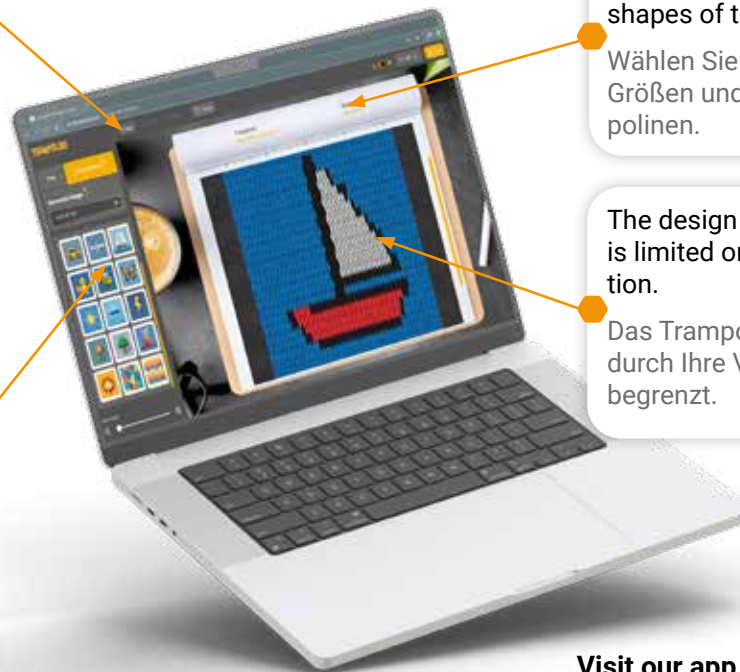

Visit our app

Besuchen Sie unsere App



tdesign-studio.com



SFERO 



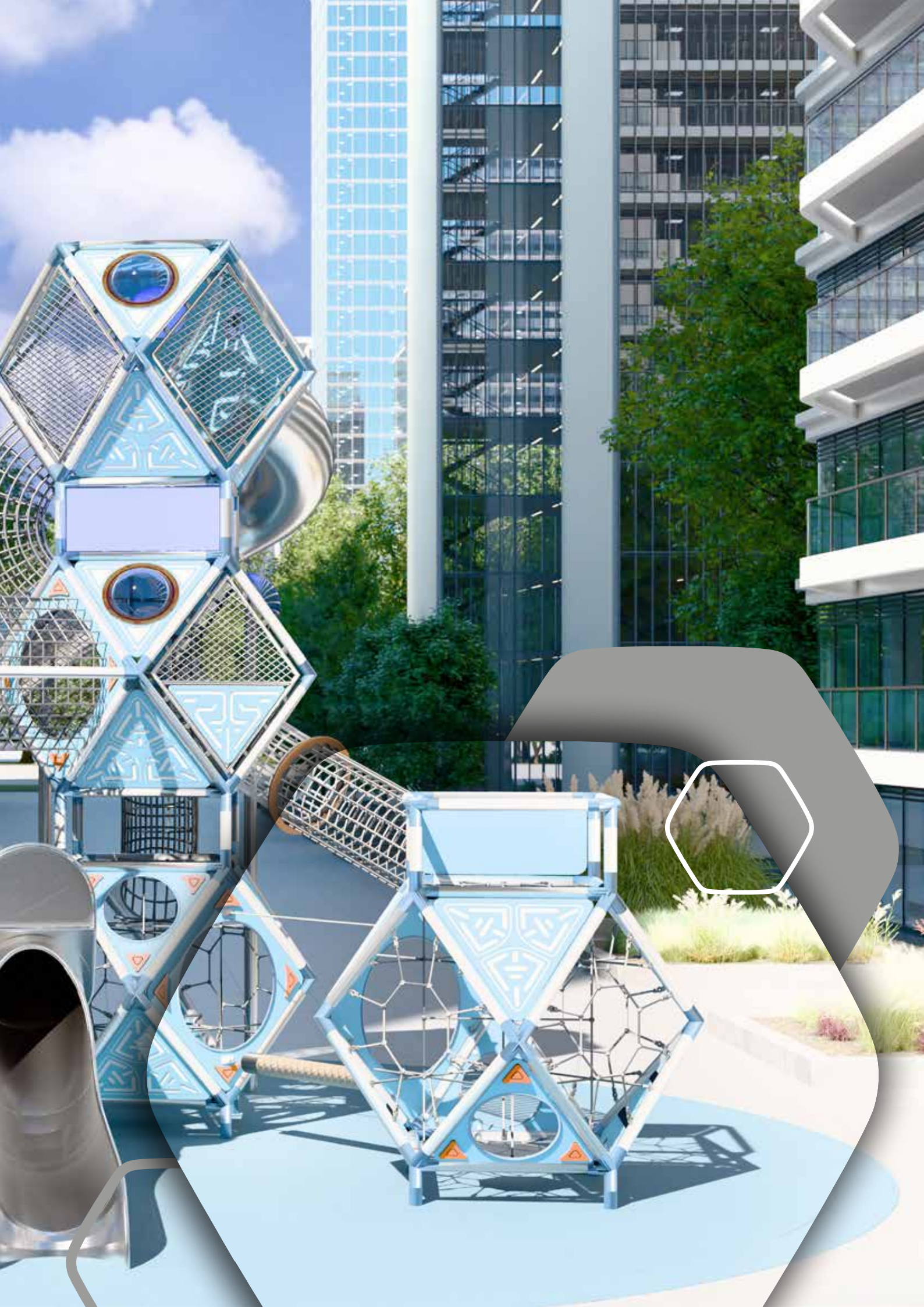

SFERO Series

A space, underwater, or forest base.
It sparks imagination and offers many
opportunities for play.

Serie SFERO

Eine Weltraumstation, Unterwasser- oder
Wald-Basis. Sie regt die Fantasie an und
bietet zahlreiche Spielmöglichkeiten.

HDPE panels with fantastic patterns
emphasize the character of the base,
transporting children into a world of
imagination.

HDPE-Platten mit fantastischen
Mustern unterstreichen den Charakter
der Basis und versetzen die Kinder in
eine Welt der Fantasie..

The powder-coated steel
structure ensures safety
during play.

Die pulverbeschichtete
Stahlkonstruktion sorgt
für Sicherheit beim
Spielen.

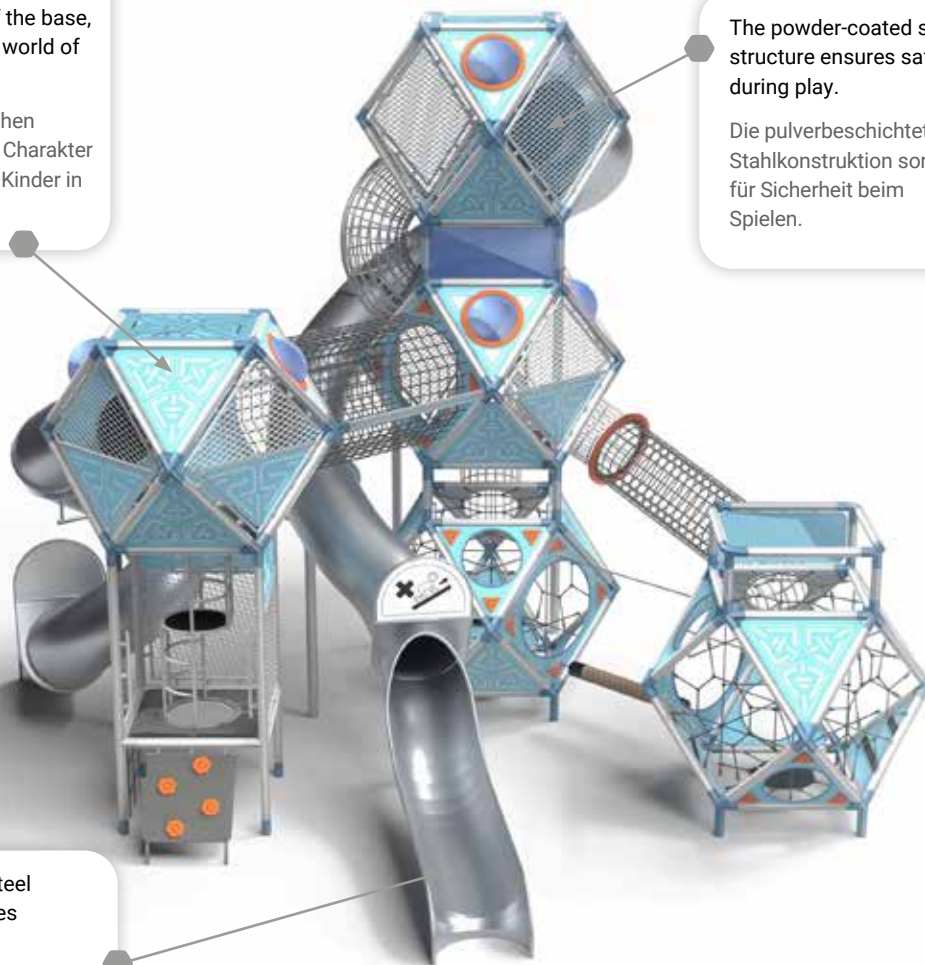

A slide made of stainless steel
or colorful plastic. It provides
excitement and great fun.

Eine Rutsche aus Edelstahl oder
farbenfrohem Kunststoff sorgt für
Nervenkitzel und großen Spielspaß.





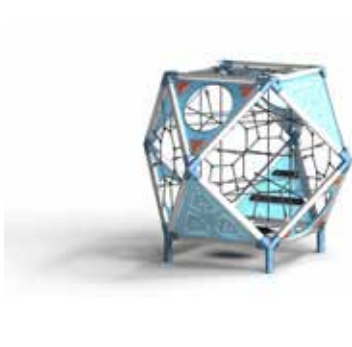

SFERO SPACE 1-1
01-SF-711-S



SFERO SPACE 1-2
01-SF-712-X-S

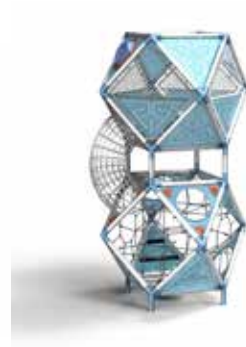

SFERO SPACE 2-1
01-SF-721-S









SFERO SPACE 2-2
01-SF-722-X-S



SFERO SPACE 3-1
01-SF-731-X-S



SFERO SPACE 4-1
01-SF-741-X-S

								
SFERO SPACE 1-1	01-SF-711-S			1,93 x 1,93 x 2,18	5,93 x 5,93	2,18	6+	15
SFERO SPACE 1-2	01-SF-712-X-S			6,85 x 2,7 x 3,09	10,85 x 6,7	2,18	6+	18
SFERO SPACE 2-1	01-SF-721-S			2,14 x 2,14 x 4,62	6,6 x 6,6	2,76	6+	16
SFERO SPACE 2-2	01-SF-722-X-S			3,83 x 4,07 x 4,62	6,6 x 7,5	2,76	6+	19
SFERO SPACE 3-1	01-SF-731-X-S			7,47 x 4,3 x 4,62	10,1 x 7,5	2,76	6+	39
SFERO SPACE 4-1	01-SF-741-X-S			9,6 x 8,18 x 4,62	14 x 11,8	2,76	6+	61
SFERO SPACE 5-1	01-SF-751-X-S			7,3 x 8,8 x 7,06	10,5 x 12,7	2,76	6+	71

SFERO SPACE 5-1
01-SF-751-X-S





SFERO FOREST 1-1
01-SF-711-F



SFERO FOREST 1-2
01-SF-712-P-F



SFERO FOREST 2-1
01-SF-721-F



SFERO FOREST 2-2
01-SF-722-P-F



SFERO FOREST 3-1
01-SF-731-P-F



SFERO FOREST 4-1
01-SF-741-P-F



SFERO FOREST 1-1	01-SF-711-F	1,93 x 1,93 x 2,18	5,93 x 5,93	2,18	6+	15
SFERO FOREST 1-2	01-SF-712-P-F	6,85 x 2,7 x 3,09	10,85 x 6,7	2,18	6+	18
SFERO FOREST 2-1	01-SF-721-F	2,14 x 2,14 x 4,62	6,6 x 6,6	2,76	6+	16
SFERO FOREST 2-2	01-SF-722-P-F	3,83 x 4,07 x 4,62	6,6 x 7,5	2,76	6+	19
SFERO FOREST 3-1	01-SF-731-P-F	7,47 x 4,3 x 4,62	10,1 x 7,5	2,76	6+	39
SFERO FOREST 4-1	01-SF-741-P-F	9,6 x 8,18 x 4,62	14 x 11,8	2,76	6+	61
SFERO FOREST 5-1	01-SF-751-P-F	7,3 x 8,8 x 7,06	10,5 x 12,7	2,76	6+	71



SFERO FOREST 5-1
01-SF-751-P-F



limako







The LIMAKO series is snail-inspired and uniquely designed.

Die LIMAKO-Serie hat ein einzigartiges, von Schnecken inspiriertes Design und schöne, lebendige Farben.

A stainless steel construction maintains its modern look for years and does not require painting.

Eine Edelstahlkonstruktion bewahrt ihr modernes Aussehen über Jahre und erfordert keine Lackierung.

Durable polypropylene ropes, reinforced with a steel core ensures safety while playing.

Langlebige Polypropylen-Seile, sind mit einem Stahlkern verstärkt und sorgen für Sicherheit beim Spielen.

Entrance gangways and the climbing walls are made of HDPE which do not tear off and are easy to keep clean. Its vivid colours enhance the aesthetic value of the playground

Die Kletterwände sind aus HDPE-Platten hergestellt, die beim intensiven Nutzung nicht verschleßen und leicht zu reinigen sind. Ihre lebendigen Farben unterstreichen den ästhetischen Wert des Spielplatzes. erfordert keine Lackierung.

Extremely durable HPL platform board is equipped with non-slip structure that ensures safety and limits possibility of uncontrolled slippage during play.

Langlebige HPL- Platte mit einer rutschfesten Struktur gewährleistet die Sicherheit und begrenzt die Möglichkeit des unkontrollierten Rutschens während des Spiels.

Slides | Rutschen

- Option I - stainless steel
- Option II - plastic
- Variante I - Edelstahl
- Variante II - Kunststoff



Installation | Montagearten

- Option I - to embed
- Option II - concrete version
- Variante I - zum Einbetonieren
- Variante II - zum Verschrauben





INFANO 1
K751







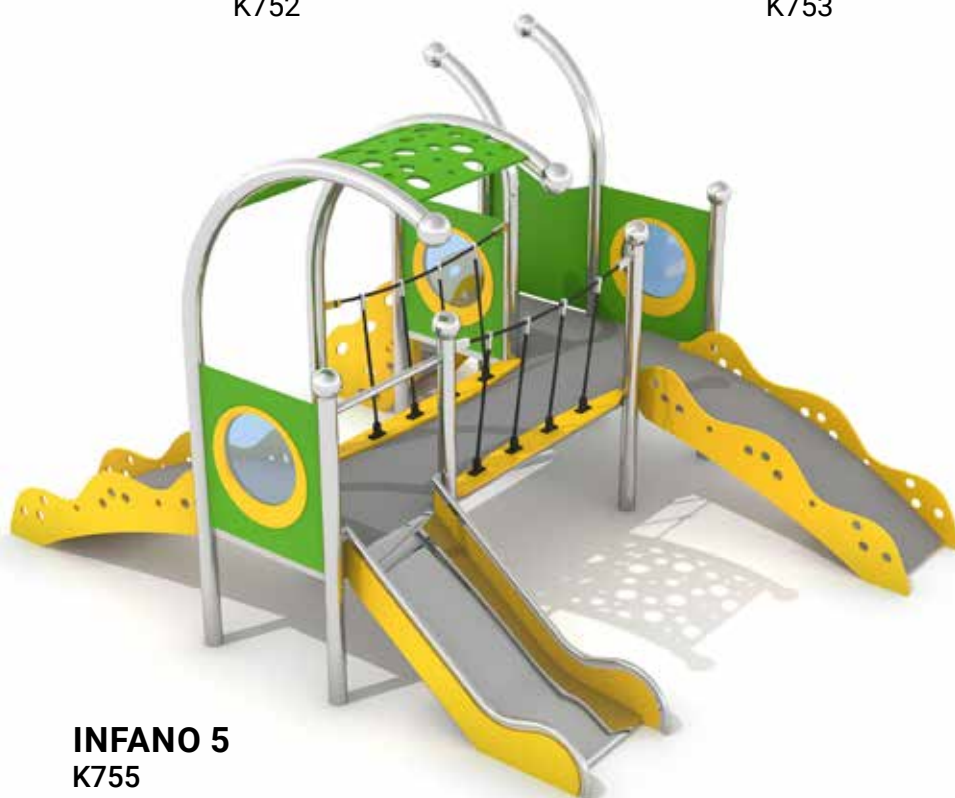

INFANO 2
K752



INFANO 3
K753



INFANO 5
K755

							
INFANO 1	K751	1,33 x 1,00 x 2,25	4,33 x 4,00	0,55	1+	2	
INFANO 2	K752	2,04 x 1,44 x 2,08	5,54 x 4,44	0,59	1+	3	
INFANO 3	K753	2,50 x 0,80 x 2,00	6,01 x 3,78	0,59	1+	3	
INFANO 5	K755	3,59 x 3,09 x 2,49	6,89 x 6,09	0,59	1+	5	
INFANO 4	K754	3,08 x 2,59 x 2,49	6,08 x 6,09	0,59	1+	5	
INFANO 6	K756	3,39 x 2,93 x 2,25	6,89 x 5,93	0,59	1+	4	



INFANO 4
K754



INFANO 6
K756





DOMETO 1-1
K511



DOMETO 1-2
K512



DOMETO 2-1
K521







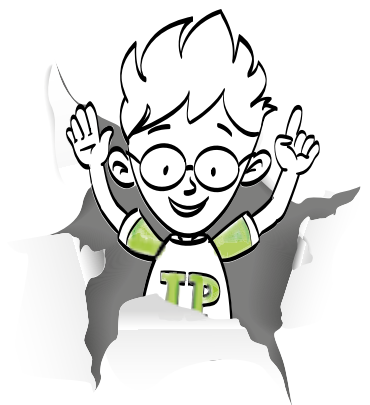

DOMETO 2-2
K522



DOMETO 2-3
K523



								
DOMETO 1-1	K511			3,42 x 1,70 x 2,40	6,92 x 4,70	0,90	3+	3
DOMETO 1-2	K512			3,42 x 1,70 x 2,80	6,92 x 4,70	0,90	3+	3
DOMETO 2-1	K521			5,60 x 2,01 x 2,80	9,10 x 5,01	0,90	3+	5
DOMETO 2-2	K522			4,48 x 3,94 x 2,80	7,48 x 7,94	0,90	3+	5
DOMETO 2-3	K523			6,18 x 3,94 x 2,80	9,18 x 7,94	0,90	3+	5
DOMETO 3-1	K531			6,17 x 5,60 x 2,80	9,17 x 9,10	0,90	3+	8
DOMETO 3-2	K532			8,85 x 3,75 x 2,80	12,35 x 7,25	0,90	3+	9
DOMETO 4-1	K541			6,12 x 6,80 x 2,80	10,12 x 9,80	0,90	3+	12



DOMETO 3-1
K531



DOMETO 3-2
K532



DOMETO 4-1
K541





DOMO 1-1
K611



DOMO 1-2
K612









DOMO 2-1
K621



DOMO 4-1
K641



							
DOMO 1-1	K611	4,39 x 6,26 x 3,73	7,39 x 9,80	2,50	6+	9	
DOMO 1-2	K612	6,65 x 3,67 x 3,56	10,38 x 7,12	2,50	6+	10	
DOMO 2-1	K621	6,02 x 3,33 x 3,73	9,02 x 7,17	2,50	6+	8	
DOMO 2-2	K622	6,76 x 3,59 x 3,73	10,27 x 6,60	2,50	6+	4	
DOMO 2-3	K623	7,95 x 2,62 x 3,73	11,93 x 5,62	2,50	6+	8	
DOMO 2-4	K624	7,57 x 5,44 x 3,73	11,26 x 8,69	2,50	6+	14	
DOMO 4-1	K641	9,73 x 6,82 x 3,73	13,23 x 10,32	2,50	6+	14	



DOMO 2-2
K622



DOMO 2-3
K623



DOMO 2-4
K624











DOMO 3-1
K631



DOMO 3-2
K632



DOMO 3-3
K633

						
DOMO 3-1	K631	8,22 x 5,25 x 3,56	12,22 x 8,25	2,50	6+	11
DOMO 3-2	K632	11,03 x 4,15 x 3,87	14,49 x 7,65	2,50	6+	15
DOMO 3-3	K633	9,62 x 3,42 x 3,43	12,90 x 6,92	2,50	6+	15
RIDO 1	K801	3,70 x 2,25 x 2,35	7,20 x 5,25	0,59	1+	5
RIDO 2	K802	2,57 x 0,91 x 1,85	5,57 x 3,91	0,35	1+	4



RIDO 1
K801



RIDO 2
K802





ESKALO 1
K701



ESKALO 2
K702



ESKALO 3
K703









ESKALO 4
K704



ESKALO 5
K705



ESKALO 6
K706

								
ESKALO 1	K701	3,67 x 1,73 x 2,90	7,37 x 5,43	2,00	6+	8		
ESKALO 2	K702	4,11 x 2,15 x 2,84	7,65 x 5,25	2,00	6+	9		
ESKALO 3	K703	4,60 x 3,80 x 2,90	8,07 x 7,37	2,00	6+	16		
ESKALO 7	K707	6,77 x 6,20 x 2,89	11,03 x 9,20	2,00	6+	16		
ESKALO 4	K704	5,10 x 3,56 x 2,85	8,34 x 7,04	2,00	6+	11		
ESKALO 5	K705	6,97 x 2,95 x 3,20	10,30 x 7,03	2,00	6+	14		
ESKALO 6	K706	6,09 x 1,73 x 2,89	9,62 x 5,40	2,00	6+	12		
ESKALO 8	K708	4,63 x 5,22 x 3,31	8,62 x 8,22	2,00	6+	15		



ESKALO 7
K707



ESKALO 8
K708





VERGO
K301



BIRDO
K302



KOMBINO
K309



ARCO
K303



VERGO	K301	2,75 x 0,35 x 2,35	7,50 x 1,75	1,30	3+	2
BIRDO	K302	3,34 x 1,00 x 2,40	7,50 x 2,35	1,30	3+	2
ARCO	K303	4,66 x 1,27 x 2,50	7,50 x 4,85	1,30	3+	4
PENDOLO	K308	3,83 x 2,08 x 2,52	3,17 x 7,50	1,30	1+	2
NESTO	K310	3,03 x 2,17 x 2,52	2,35 x 7,50	1,30	3+	2
FRAMO	K307	2,37 x 2,08 x 2,52	7,5 x 1,75	1,30	3+	1
KOMBINO	K309	6,14 x 2,08 x 2,52	5,58 x 7,50	1,30	3+	4
BALANCILO 1	K201	2,65 x 0,50 x 0,85	4,65 x 2,50	0,80	3+	2
BALANCILO 2	K202	2,85 x 0,50 x 1,00	4,85 x 2,50	0,80	3+	2

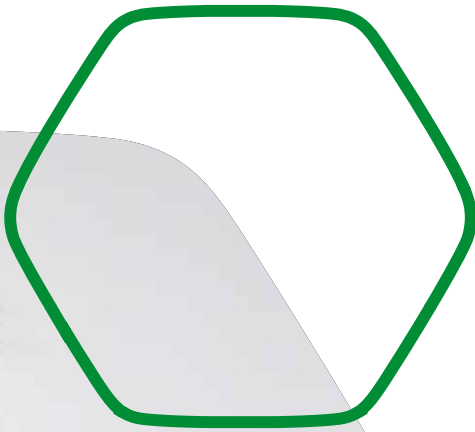

PENDOLO
K308



FRAMO
K307



BALANCILO 1
K201



BALANCILO 2
K202



NESTO
K310



MIKSI
IS-IN-301



ENIRO
K304









TURNADO
K101



RANDO
K104



								
MIKSI	IS-IN-301			7,54 x 2,25 x 2,52	6,89 x 7,80	1,30	3+	4
ENIRO	K304			5,05 x 3,18 x 2,40	7,50 x 3,15	1,30	3+	4
TURNADO	K101			1,50 x 1,50 x 0,80	5,50 x 5,50	1,00	3+	6
RANDO	K104			1,22 x 1,22 x 1,10	5,22 x 5,22	1,00	3+	5
PLATFORMO	K102			1,50 x 1,50 x 0,80	5,50 x 5,50	1,00	3+	6
POKALO	K105			1,80 x 1,80 x 0,77	5,80 x 5,80	1,00	3+	8
GLOBO	K103			1,22 x 1,22 x 1,10	5,22 x 5,22	1,00	3+	8



POKALO
K105









PLATFORMO
K102



GLOBO
K103





						
TELERO 1	K106-GV	0,70 x 0,70 x 0,40	6,70 x 6,70	1,00	3+	2
TELERO 2	K107-GV	2,00 x 2,00 x 0,50	8,00 x 8,00	1,00	3+	5
SIDI 1	K411	0,63 x 0,46 x 0,79	3,46 x 3,63	0,46	3+	1
SIDI 2	K412	1,66 x 0,46 x 0,79	4,66 x 3,46	0,46	3+	3
SIDI 3	K413	2,00 x 2,31 x 0,78	5,31 x 5,00	0,46	3+	4
SIDENTA 2	K422	1,86 x 1,10 x 0,94	4,86 x 4,10	0,46	3+	4
RINGO	K441	1,50 x 1,50 x 0,43	4,50 x 4,50	0,46	3+	8
SALTI 2	K432	1,10 x 1,10 x 0,43	4,10 x 4,10	0,46	3+	4
SALTI 1	K431	0,40 x 0,40 x 0,41	3,40 x 3,40	0,46	3+	1



TELERO 1
K106-GV

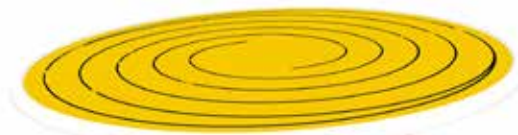

TELERO 2
K107-GV



SIDI 1
K411



SIDI 2
K412



SIDI 3
K413



SIDENTA 2
K422



SALTI 1
K431



SALTI 2
K432

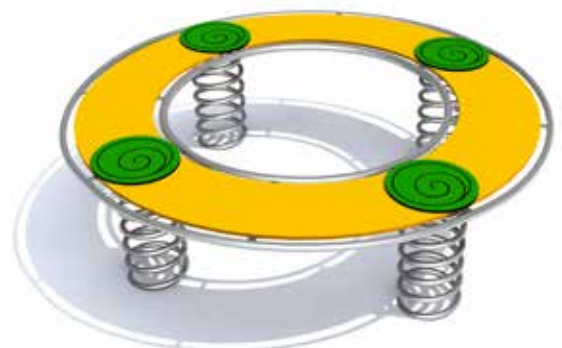

RINGO
K441



VOCO
K1151



TABLO
K930



STATIVO
K940

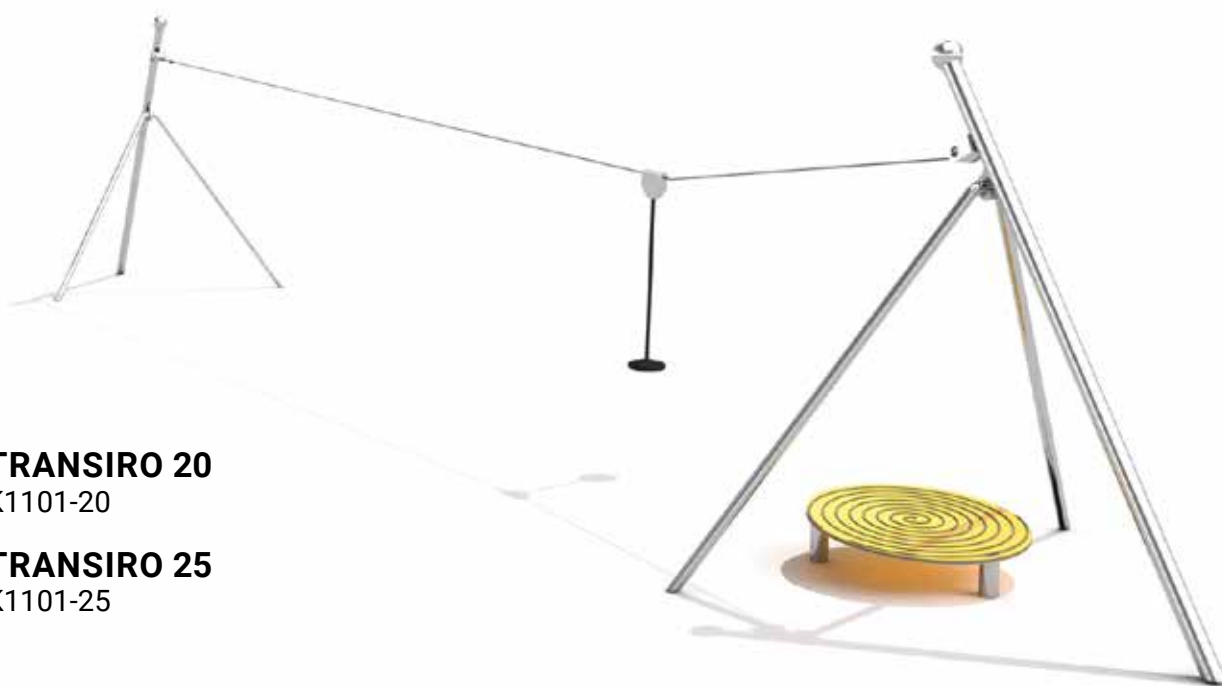

TRANSIRO 20
K1101-20

TRANSIRO 25
K1101-25



VOCO	K1151	0,41 x 0,15 x 1,29	-		3+	2
TABLO	K930	48,5 x 98,5	-			
STATIVO	K940	1,50 x 0,07 x 1,25	-			
TRANSIRO 20	K1101-20	25,42 x 4,57 x 4,50	24,73 x 4,00	0,99	3+	1
TRANSIRO 25	K1101-25	30,42 x 4,57 x 4,65	29,73 x 4,00	0,99	3+	1



RUBO
K920







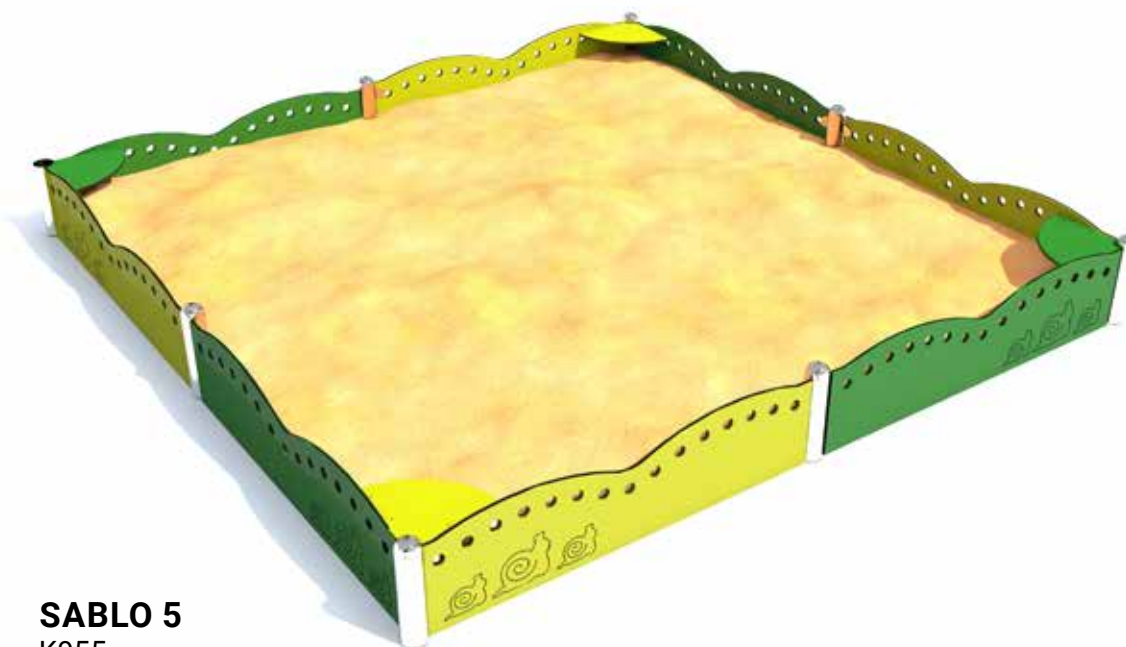

SEGO 1
K901



SEGO 2
K902



SABLO 5
K955

								
RUBO	K920			0,48 x 0,72 x 1,05	-	-	-	-
SEGO 1	K901			1,55 x 0,61 x 0,83	-	-	-	-
SEGO 2	K902			1,60 x 0,66 x 1,05	-	-	-	-
SABLO 1	K951			1,50 x 1,50 x 0,35	4,50 x 4,50		1+	5
SABLO 2	K952			2,00 x 2,00 x 0,35	5,00 x 5,00		1+	9
SABLO 3	K953			1,50 x 1,50 x 0,35	4,50 x 4,50		1+	5
SABLO 4	K954			2,00 x 2,00 x 0,35	5,00 x 5,00		1+	9
SABLO 5	K955			2,92 x 2,92 x 0,35	5,92 x 5,92		1+	16

The Lumo Board

is a new addition to the market, standing out with its unique design and functionality. It's the perfect combination of fun and sensory development for young children.

Die LUMO Spieltafel

ist eine Neuheit auf dem Markt und zeichnet sich durch sein einzigartiges Design und seine Funktionalität aus. Es ist die perfekte Kombination aus Spielspaß und sensorischer Entwicklung für Kleinkinder.

Sensory stimulation:

The board is equipped with rotating elements that light up, engaging a child's senses.

Eye-catching graphics:

The themed, colorful design makes the board exceptionally attractive.

Magical light effect:

The glowing circles create fascinating visual effects, enhancing the joy of play.

Engaging challenge:

Children can try to light up all the circles at once, developing their motor skills and coordination.

Sensorische Stimulation:

die Spieltafel ist mit drehbaren Elementen ausgestattet, die aufleuchten und die Sinne des Kindes ansprechen.

Auffällige Grafiken:

Das thematische, bunte Design macht die Spieltafel besonders attraktiv.

Magischer Lichteffekt:

Die leuchtenden Kreise erzeugen faszinierende visuelle Effekte und steigern die Freude am Spielen.

Fesselnde Herausforderung:

Kinder können versuchen, alle Kreise gleichzeitig zum Leuchten zu bringen, wodurch ihre motorischen Fähigkeiten und die Koordination gefördert werden.



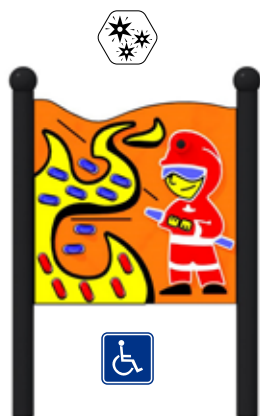

**FIREFIGHTER
LUMO**
01-TA-814-LP



DIVER LUMO
01-TA-803-LP

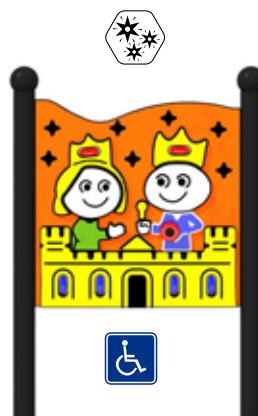

CASTLE LUMO
01-TA-813-LP



**GHOSTS 1
LUMO**
01-TA-802-LP



**GHOSTS 2
LUMO**
01-TA-812-LP



**ROCKET 1
LUMO**
01-TA-800-LP



**ROCKET 2
LUMO**
01-TA-810-LP



**ROCKET 3
LUMO**
01-TA-811-LP



FIREFIGHTER LUMO	01-TA-814-LP	0,90 x 0,10 x 1,25	3,90 x 3,10	-	2+	2
DIVER LUMO	01-TA-803-LP	0,90 x 0,10 x 1,25	3,90 x 3,10	-	2+	2
CASTLE LUMO	01-TA-813-LP	0,90 x 0,10 x 1,25	3,90 x 3,10	-	2+	2
GHOSTS 1 LUMO	01-TA-802-LP	0,90 x 0,10 x 1,25	3,90 x 3,10	-	2+	2
GHOSTS 2 LUMO	01-TA-812-LP	0,90 x 0,10 x 1,25	3,90 x 3,10	-	2+	2
ROCKET 1 LUMO	01-TA-800-LP	0,90 x 0,10 x 1,25	3,90 x 3,10	-	2+	2
ROCKET 2 LUMO	01-TA-810-LP	0,90 x 0,10 x 1,25	3,90 x 3,10	-	2+	2
ROCKET 3 LUMO	01-TA-811-LP	0,90 x 0,10 x 1,25	3,90 x 3,10	-	2+	2



SPIDER LUMO
01-TA-809-LP



BEE LUMO
01-TA-808-LP

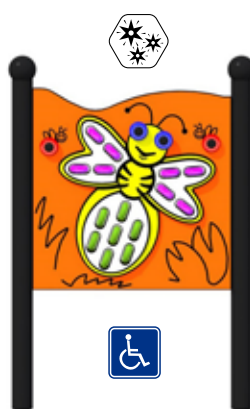



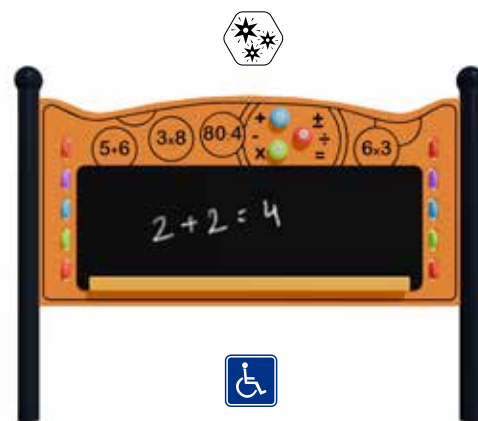

FIREFLY LUMO
01-TA-801-LP



DRAWING BOARD LUMO
01-TA-832-LP



								
SPIDER LUMO	01-TA-809-LP	0,90 x 0,10 x 1,25	3,90 x 3,10	-	2+	2		
BEE LUMO	01-TA-808-LP	0,90 x 0,10 x 1,25	3,90 x 3,10	-	2+	2		
FIREFLY LUMO	01-TA-801-LP	0,90 x 0,10 x 1,25	3,90 x 3,10	-	2+	2		
DRAWING BOARD LUMO	01-TA-832-LP	1,65 x 0,1 x 1,25	4,65 x 3,1	-	2+	4		



ROBOTS 1 LUMO
01-TA-804-LP

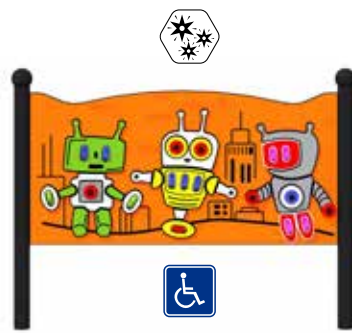

ROBOTS 2 LUMO
01-TA-822-LP



ROBOTS 3 LUMO
01-TA-823-LP



DOGS LUMO
01-TA-821-LP



CATS LUMO
01-TA-820-LP



DINO LUMO
01-TA-806-LP



ROBOTS 1 LUMO	01-TA-804-LP	1,65 x 0,10 x 1,25	4,65 x 3,10	-	2+	4	
ROBOTS 2 LUMO	01-TA-822-LP	1,65 x 0,10 x 1,25	4,65 x 3,10	-	2+	4	
ROBOTS 3 LUMO	01-TA-823-LP	1,65 x 0,10 x 1,25	4,65 x 3,10	-	2+	4	
DOGS LUMO	01-TA-821-LP	1,65 x 0,10 x 1,25	4,65 x 3,10	-	2+	4	
CATS LUMO	01-TA-820-LP	1,65 x 0,10 x 1,25	4,65 x 3,10	-	2+	4	
DINO LUMO	01-TA-806-LP	1,65 x 0,10 x 1,25	4,65 x 3,10	-	2+	4	



DRAGON 1 LUMO
01-TA-807-LP



DRAGON 2 LUMO
01-TA-818-LP



DRAGON 3 LUMO
01-TA-819-LP





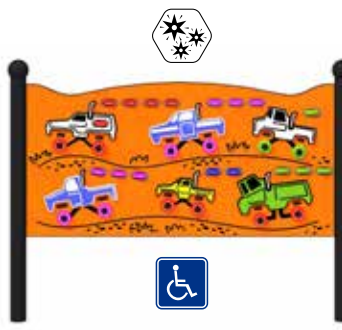



CARS 1 LUMO
01-TA-805-LP



CARS 2 LUMO
01-TA-816-LP



CARS 3 LUMO
01-TA-817-LP

							
DRAGON 1 LUMO	01-TA-807-LP	1,65 x 0,10 x 1,25	4,65 x 3,10	-	2+	4	
DRAGON 2 LUMO	01-TA-818-LP	1,65 x 0,10 x 1,25	4,65 x 3,10	-	2+	4	
DRAGON 3 LUMO	01-TA-819-LP	1,65 x 0,10 x 1,25	4,65 x 3,10	-	2+	4	
CARS 1 LUMO	01-TA-805-LP	1,65 x 0,10 x 1,25	4,65 x 3,10	-	2+	4	
CARS 2 LUMO	01-TA-816-LP	1,65 x 0,10 x 1,25	4,65 x 3,10	-	2+	4	
CARS 3 LUMO	01-TA-817-LP	1,65 x 0,10 x 1,25	4,65 x 3,10	-	2+	4	



WORLD OF VEHICLES 1 LUMO
01-TA-828-LP



WORLD OF ANIMALS 1 LUMO
01-TA-831-LP



WORLD OF DRAGONS 1 LUMO
01-TA-830-LP

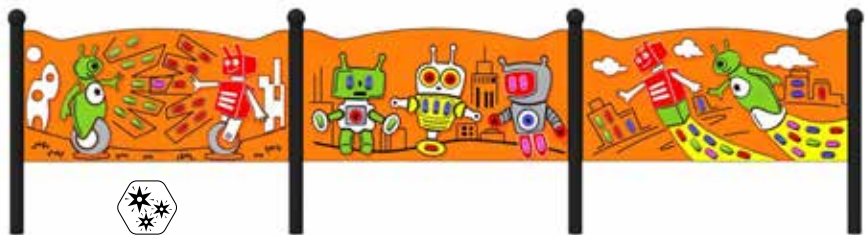

WORLD OF ROBOTS 1 LUMO
01-TA-829-LP



Product Name	Code	Dimensions (L x W x H)	Length x Width	Height	Age Suitability	Pieces
WORLD OF VEHICLES 1 LUMO	01-TA-828-LP	4,80 x 0,10 x 1,25	7,80 x 3,10	-	2+	12
WORLD OF ANIMALS 1 LUMO	01-TA-831-LP	4,80 x 0,10 x 1,25	7,80 x 3,10	-	2+	12
WORLD OF DRAGONS 1 LUMO	01-TA-830-LP	4,80 x 0,10 x 1,25	7,80 x 3,10	-	2+	12
WORLD OF ROBOTS 1 LUMO	01-TA-829-LP	4,80 x 0,10 x 1,25	7,80 x 3,10	-	2+	12

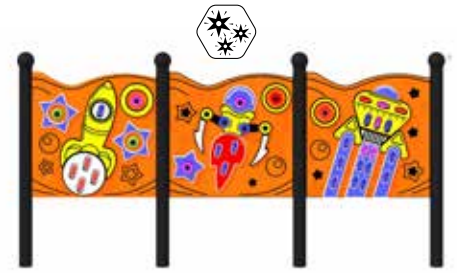

WORLD OF STARS 1
01-TA-827-LP



WORLD OF BUGS 1 LUMO
01-TA-826-LP



WORLD OF STORIES 1 LUMO
01-TA-825-LP



WORLD OF HEROES 1 LUMO
01-TA-824-LP



WORLD OF STARS 1	01-TA-827-LP	4,80 x 0,10 x 1,25	7,80 x 3,10	-	2+	12
WORLD OF BUGS 1 LUMO	01-TA-826-LP	4,80 x 0,10 x 1,25	7,80 x 3,10	-	2+	12
WORLD OF STORIES 1 LUMO	01-TA-825-LP	4,80 x 0,10 x 1,25	7,80 x 3,10	-	2+	12
WORLD OF HEROES 1 LUMO	01-TA-824-LP	4,80 x 0,10 x 1,25	7,80 x 3,10	-	2+	12

integrado





SAFETY SYSTEM

1 — 2 — 3 — 4 — 5

Swing | Schaukel

SATURN

1

Shock absorber prevents from excessive swinging of the gondola.

Der Stoßdämpfer verhindert übermäßiges Schwingen der Gondel.

2

Locking rim prevents the ramp from opening during swinging.

Das Verrigelungsband blockiert die Rampeneröffnung während des Schwingens.

3

Gondola's stabilizer makes entry of wheelchair users easier.

Der Stabilisator erleichtert die Einfahrt für Rollstuhlfahrer.

5

„Lock system” immobilizes the gondola and prevents the swing from use of unauthorized persons.

„Lock system” schützt vor der unbefugten Verwendung.

4

Rubber bumpers protects persons being in safety zone.

Weiche Stoßstangen schützen die sich an die Gondelbewegungszone annähernde Personen vom Verletzungen.



Skid-shaped gondola's stabilizer making easier entry for wheelchair

Das Stabilisierungsgestell für die Rollstuhlfahrer.



„Lock system” immobilizes the gondola and prevents the swing from use of unauthorized persons.

„Lock system” der vor der unbefugten Schaukelbenutzung schützt.





SATURN
GM1611



SATURN XXL
GM1612



For electric wheelchair
Für elektrischen Rollstuhl



SATURN	GM1611	1,89 x 2,87 x 2,66	7,00 x 2,55	1,13	1+	1	
SATURN XXL	GM1612	1,98 x 3,70 x 2,71	7,00 x 3,00	1,13	1+	1	

1

When the gates are opened the roundabout is immobilized. Rotation is only possible if all gates are closed.

Wenn die Pforten geöffnet sind, ist das Karussell blockiert und dreht sich nicht. Das Drehen ist erst möglich, wenn alle Tore geschlossen sind.

SAFETY SYSTEM

1 — 2 — 3 — 4

Inclusive roundabout | Inklusive Karussell
YUGO

4

Opening the gate while the roundabout rotates causes the device to slow down and stop.

Das Öffnen der Pforten während sich das Karussell dreht, verursacht eine automatische Ausbremsung bis zum Anhalten.

2

The centrifugal brake prevents the roundabout from rotating too quickly.

Eine Fliehkraftbremse verhindert zu schnelle Drehung.

3

Turning the handle allows to open the gate.

Das Tor öffnet sich, wenn die Knöpfe gedreht werden.

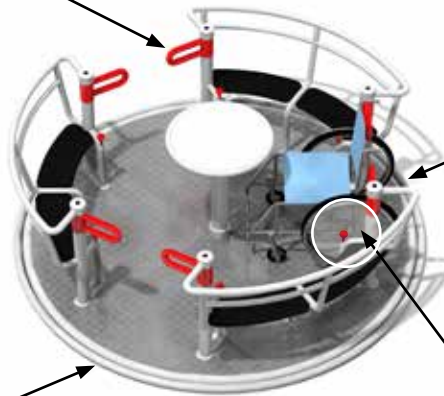

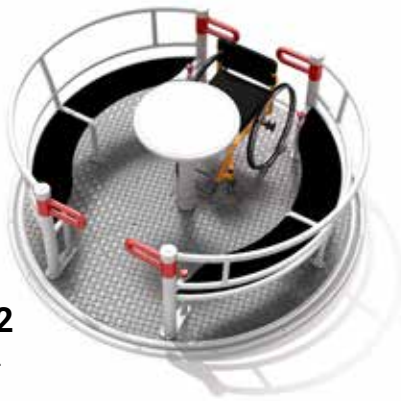

YUGO 2
GM0622

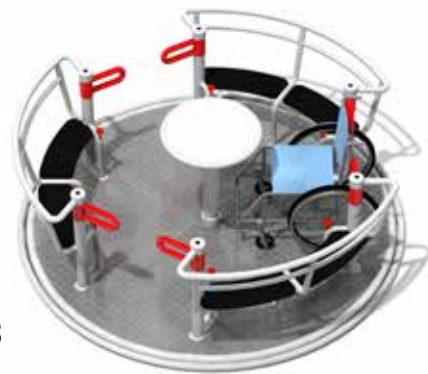

YUGO 3
GM0621

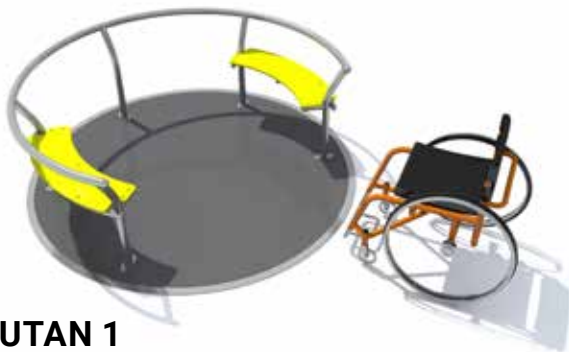

AUTAN 1
IS-IN-101



AUTAN 2
IS-IN-102





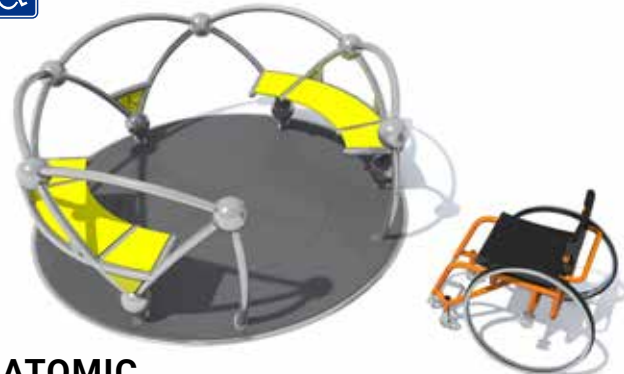



AUTAN 3
IS-IN-103



ATOMIC
IS-IN-111



							
YUGO 2	GM0622	2,20 x 2,20 x 0,79	6,20 x 6,20	1,00	3+	6	
YUGO 3	GM0621	2,47 x 2,47 x 0,79	6,47 x 6,47	1,00	3+	9	
AUTAN 1	IS-IN-101	1,89 x 1,89 x 0,63	5,89 x 5,89	1,00	3+	5	
AUTAN 2	IS-IN-102	2,13 x 2,13 x 0,71	6,14 x 6,14	1,00	3+	5	
AUTAN 3	IS-IN-103	2,14 x 2,14 x 1,00	6,14 x 6,14	1,00	3+	4	
ATOMIC	IS-IN-111	2,14 x 2,14 x 0,83	6,14 x 6,14	1,00	3+	9	

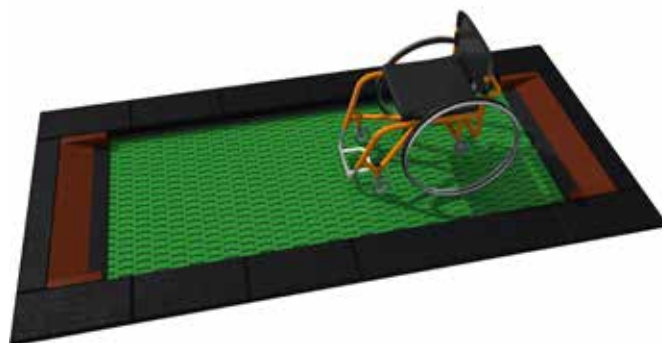
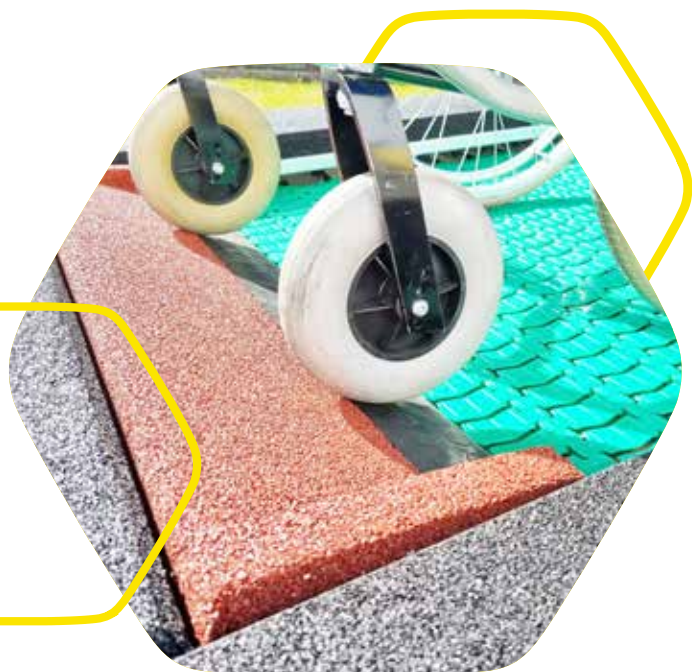

ORTA-I 150 X 250
MA-SA-43-I



FESTO MINI LUMO
IS-MM-001



FESTO LUMO
IS-MM-002



ORTA-I 150 X 200	MA-SA-41-I	1,50 x 2,00	4,00 x 4,25	0,90	3+	1
ORTA-I 150 X 250	MA-SA-43-I	1,50 x 2,50	5,00 x 5,75	0,90	3+	2
ORTA-I 150 X 300	MA-SA-46-I	1,50 x 3,00	5,00 x 6,25	0,90	3+	2
ORTA-I 150 X 500	MA-SA-47-I	1,50 x 5,00	5,00 x 8,25	0,90	3+	4
FESTO MINI LUMO	IS-MM-001	1,42 x 1,50 x 0,59	4,50 x 4,42	0,59	3+	6
FESTO LUMO	IS-MM-002	2,00 x 2,00 x 0,80	5,00 x 5,00	0,8	3+	8

SOMERO 1
CT-IN-01

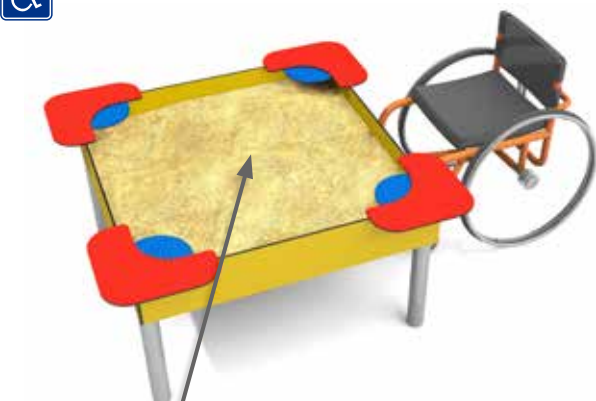

Find the fossil at the bottom of the sandbox.

Finde das Fossil am Boden des Sandkastens.

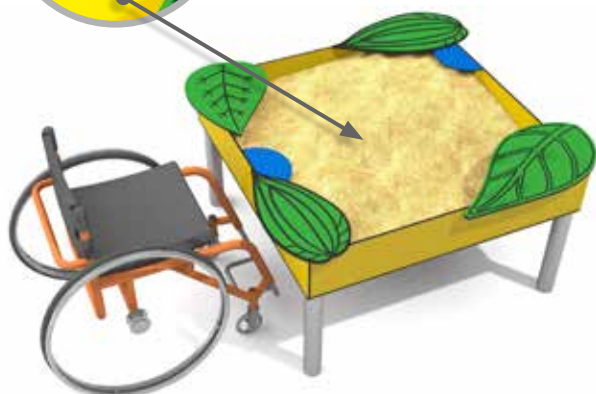

SOMERO 3
CT-IN-03

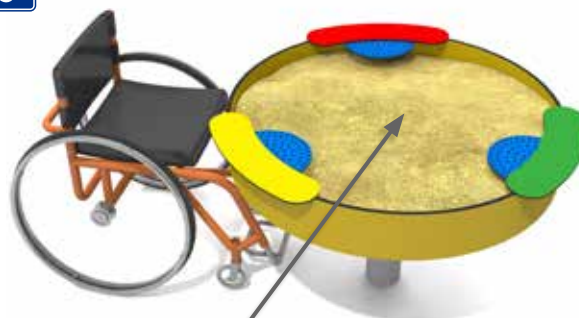

Find the fossil at the bottom of the sandbox.

Finde das Fossil am Boden des Sandkastens.



SOMERO 2
CT-IN-02



SOMERO 4
CT-IN-04



SOMERO 1	CT-IN-01	1,20 x 1,18 x 0,95	4,20 x 4,18	-	3+	4	
SOMERO 2	CT-IN-02	1,17 x 1,14 x 0,95	4,17 x 4,14	-	3+	4	
SOMERO 3	CT-IN-03	1,40 x 1,40 x 0,95	4,40 x 4,40	-	3+	3	
SOMERO 4	CT-IN-04	1,21 x 1,21 x 0,95	4,21 x 4,21	-	3+	3	



KOTO 1A
CT-IN-05



KOTO 1B
CT-IN-06



Mix sand
Gib dem Sand



with water
das Wasser zu



and play with it.
und spiele damit.



KOTO 2A
CT-IN-07



KOTO 2B
CT-IN-08



KOTO 1A	CT-IN-05	1,19 x 1,18 x 0,95	4,19 x 4,18	-	3+	4
KOTO 1B	CT-IN-06	1,26 x 1,22 x 0,95	4,26 x 4,22	-	3+	4
KOTO 2A	CT-IN-07	2,19 x 1,18 x 0,95	5,19 x 4,18	-	3+	6
KOTO 2B	CT-IN-08	2,20 x 1,25 x 0,95	5,20 x 4,25	-	3+	6
KOTO 3A	CT-IN-09	3,20 x 1,18 x 0,95	6,20 x 4,18	-	3+	8
KOTO 3B	CT-IN-10	3,19 x 1,30 x 0,90	6,19 x 4,30	-	3+	8
KOTO 4A	CT-IN-11	2,19 x 2,18 x 0,95	5,19 x 5,18	-	3+	8
KOTO 4B	CT-IN-12	2,34 x 2,31 x 0,95	5,34 x 5,31	-	3+	8







KOTO 3A
CT-IN-09



KOTO 3B
CT-IN-10



Mix sand  with water  and play with it. 
 Gib dem Sand  das Wasser zu  und spiele damit.



KOTO 4A
CT-IN-11



KOTO 4B
CT-IN-12





POGO
K305



MERCURY
IS-IN-302



STANDING FRAME 2
GK-IN-303



MIKSI
IS-IN-301S



DIGO-I
KS-IN-01



LIBELO
IS-IN-201



POGO	K305	3,47 x 0,75 x 2,77	2,16 x 7,80	1,30	1+	2
MERCURY	IS-IN-302	2,65 x 1,84 x 2,29	1,75 x 7,35	1,34	1+	1
MIKSI	IS-IN-301S	7,54 x 2,25 x 2,52	6,89 x 7,80	1,30	3+	4
DIGO-I	KS-IN-01	1,12 x 0,38 x 0,88	5,20 x 5,20	1,00	3+	1
LIBELO	IS-IN-201	2,38 x 0,71 x 1,31	5,38 x 3,71	0,98	3+	3
STANDING FRAME 2	GK-IN-303	2,43 x 2,06 x 2,10	5,43 x 5,06	1,97	6+	4
STANDING FRAME 1	GK-IN-302	0,87 x 0,08 x 2,10	3,87 x 3,08	1,97	6+	1





KAJO 1
K1001



KAJO 2
K1002

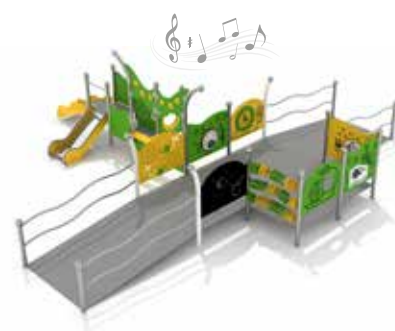

KAJO 3
K1003



CENTAUR
GK-IN-495503



DRAGON
GK-IN-495506



KAJO 1	K1001	6,36 x 3,22 x 2,25	9,36 x 6,22	0,55	3+	11
KAJO 2	K1002	8,91 x 6,39 x 2,25	11,82 x 9,38	0,55	3+	14
KAJO 3	K1003	6,36 x 6,91 x 2,24	9,91 x 9,36	0,59	3+	16
CENTAUR	GK-IN-495503	9,17 x 7,37 x 2,30	10,49 x 12,46	1,20	3+	21
DRAGON	GK-IN-495506	14,61 x 11,99 x 3,16	18,14 x 15,20	2,00	3+	37





INFANO-I 4
K754-I

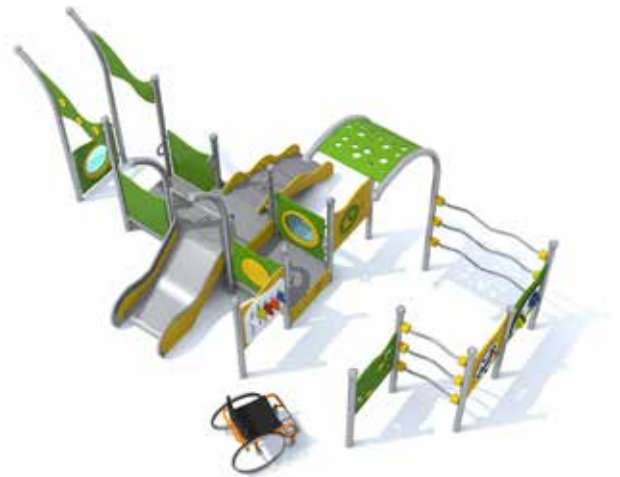

INFANO-I 5
K755-I



INFANO-I 6
K756-I



DOMETO-I 1-1
K511-I



INFANO-I 4

K754-I

6,07 x 2,84 x 2,49

9,07 x 6,34

0,59

1+

9

INFANO-I 5

K755-I

6,07 x 3,59 x 2,49

9,07 x 6,89

0,59

1+

11

INFANO-I 6

K756-I

5,92 x 3,39 x 2,25

8,92 x 6,89

0,59

1+

11

DOMETO-I 1-1

K511-I

4,86 x 4,23 x 2,40

7,85 x 7,23

0,90

3+

10

DOMETO-I 2-2

K522-I

6,75 x 5,37 x 2,80

9,75 x 8,87

0,90

3+

16

DOMETO-I 2-3

K523-I

7,82 x 5,37 x 2,80

10,82 x 8,87

0,90

3+

16



DOMETO-I 2-2
K522-I



DOMETO-I 2-3
K523-I



**DOMETO-I 1-2**

K512-I

**DOMETO-I 3-1**

K531-I

**DOMETO-I 4-1**

K541-I



DOMETO-I 1-2	K512-I	4,86 x 4,23 x 2,80	7,85 x 7,23	0,90	3+	11
DOMETO-I 3-1	K531-I	7,82 x 5,60 x 2,80	10,82 x 9,10	0,90	3+	18
DOMETO-I 4-1	K541-I	8,45 x 7,55 x 2,80	11,45 x 11,05	0,90	3+	21
DOMO-I 1-2	K612-I	7,14 x 6,65 x 3,73	10,32 x 10,38	2,50	6+	19
DOMO-I 2-1	K621-I	8,02 x 7,56 x 3,73	11,52 x 10,56	2,50	6+	22
DOMO-I 2-4	K624-I	9.20 x 9.13 x 3.73	12.42 x 12.63	2,50	6+	22

DOMO-I 1-2

K612-I



DOMO-I 2-1

K621-I



DOMO-I 2-4

K624-I

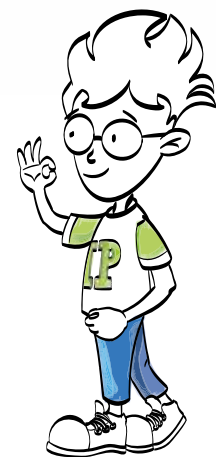





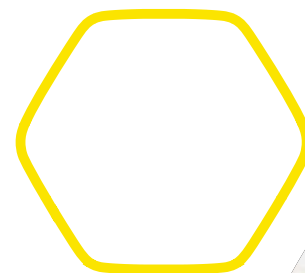



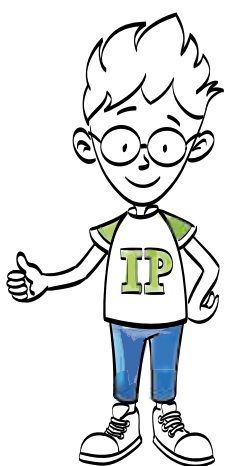

DOMO-I 4-1
K641-I



DOMO-I 2-2
K622-I



							
DOMO-I 4-1	K641-I	10.55 x 9.73 x 3.73	14.05 x 13.23	2,50	6+	31	
DOMO-I 2-2	K622-I	8,44 x 8,92 x 3,73	11,44 x 12,42	2,50	6+	20	



Music boards - electronic | Musiktafeln - elektronisch



SONO 1A
FR-IN-01



SONO 3A
FR-IN-02

Music boards - acoustic | Musiktafeln - akustisch



AKUSTIKO 1
FR-IN-03



AKUSTIKO 2
FR-IN-04



AKUSTIKO 3
FR-IN-05



SONO

0,90 x 0,10 x 1,25

3,90 x 3,10

-

3+

1

AKUSTICO

0,90 x 0,10 x 1,25

3,90 x 3,10

-

3+

1

SENSA

0,90 x 0,10 x 1,25

3,90 x 3,10

-

3+

1

Sensory boards | Sensorische Tafeln

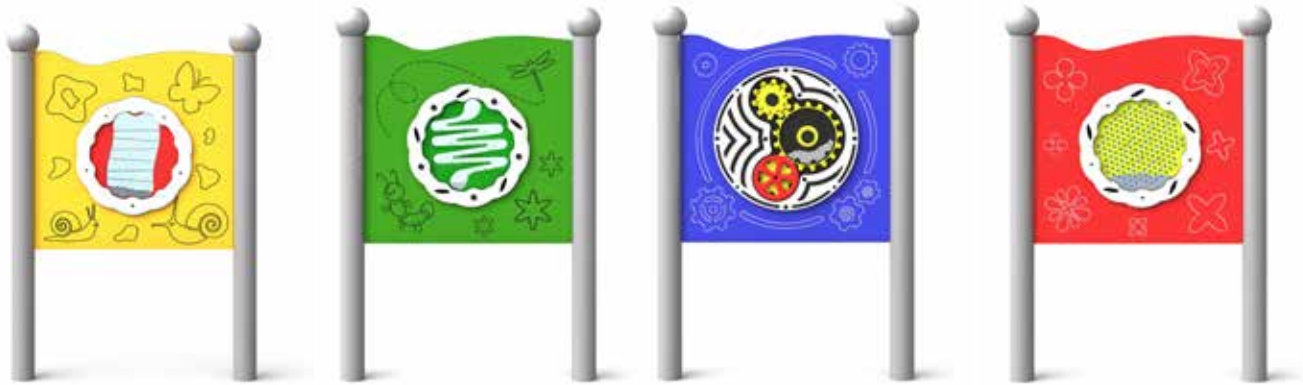

SENSA 1
FR-IN-06

SENSA 2
FR-IN-07

SENSA 3
FR-IN-08

SENSA 4
FR-IN-09

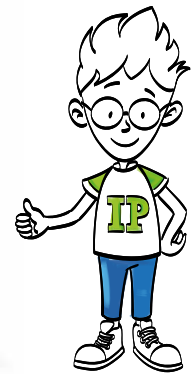

SENSA 5
FR-IN-10

SENSA 6
FR-IN-11

SENSA 7
FR-IN-12





SENSA

0,90 x 0,10 x 1,25

3,90 x 3,10

-

3+

1

EDITO SMALL

0,90 x 0,10 x 1,25

3,90 x 3,10

-

3+

1



SENSA 8
FR-IN-13



SENSA 9
FR-IN-14

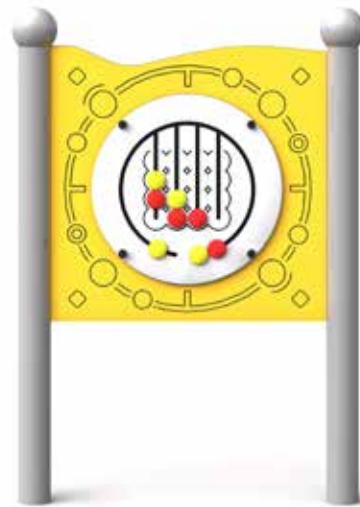

SENSA 10
FR-IN-15



SENSA 11
FR-IN-16



EDITO 1
K811



EDITO 2
K812



EDITO 3
K813



EDITO 4
K814



EDITO 5
IS-TA-101

EDITO 6
IS-TA-102

EDITO 7
IS-TA-103

EDITO 8
IS-TA-104

EDITO 9
IS-TA-105



EDITO 10
IS-TA-106

EDITO 11
IS-TA-107

EDITO 12
IS-TA-108

EDITO 13
IS-TA-109

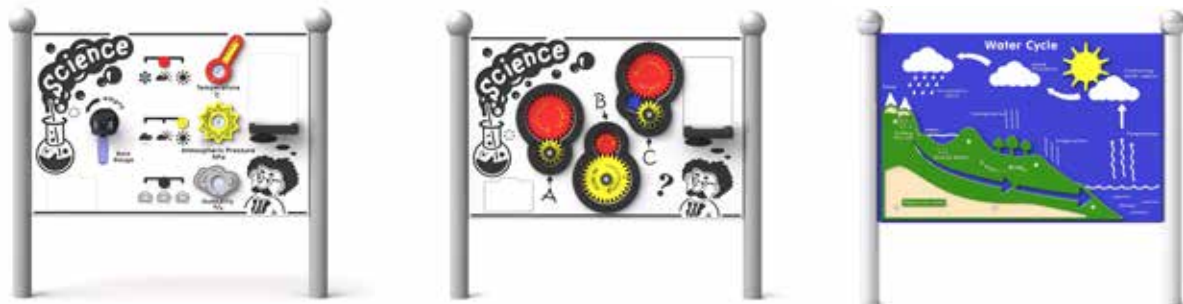

EDITO 14
IS-TA-110

EDITO 15
IS-TA-111

EDITO 16
IS-TA-112



EDITO SMALL

0,90 x 0,10 x 1,25

3,90 x 3,10

-

3+

1

EDITO MIRRORS

0,78 x 0,10 x 1,50

3,78 x 3,10

-

3+

2

EDITO BIG

1,65 x 0,10 x 1,25

4,65 x 3,10

-

3+

2



EDITO 17
IS-TA-201



EDITO 18
IS-TA-202



EDITO 19
IS-TA-203



EDITO 20
IS-TA-204





EDITO 21
IS-TA-205



EDITO 22
IS-TA-206



EDITO 23
IS-TA-207



EDITO 24
IS-TA-208

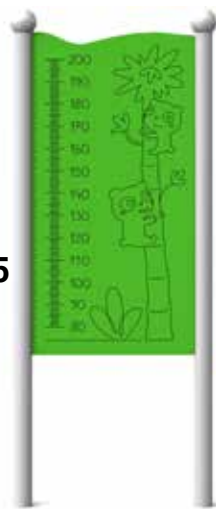

EDITO 25
IS-TA-209



EDITO 26
IS-TA-210



EDITO 27
IS-TA-113



EDITO 29
IS-TA-212



	0,90 x 0,10 x 2,22	3,90 x 3,10	-	3+	2
EDITO HIGH	0,90 x 0,10 x 2,22	3,90 x 3,10	-	3+	2
EDITO BIG	1,65 x 0,10 x 1,25	4,65 x 3,10	-	3+	2
EDITO SHOPS	0,90 x 0,10 x 1,25	3,90 x 3,10	-	3+	2
PARO	1,65 x 0,10 x 1,25	4,65 x 3,10	-	3+	2



PARO 1
FR-IN-17



PARO 2
FR-IN-18



PARO 3
FR-IN-19



PARO 4
FR-IN-20



PARO 5
FR-IN-21



PARO 6
FR-IN-22



PARO 7
FR-IN-23



PARO 8
FR-IN-24



PARO 9
FR-IN-25



PARO 10
FR-IN-26



PARO 11
FR-IN-27



PARO 12
FR-IN-28



PARO 13
FR-IN-29



PARO

1,65 x 0,10 x 1,25

4,65 x 3,10

-

3+

2

MUTAJ 3

1,16 x 1,33 x 1,50

4,16 x 4,33

-

3+

3

MUTAJ 4

1,54 x 1,54 x 1,50

4,54 x 4,54

-

3+

4



MUTAJ 3A
FR-IN-30



MUTAJ 3B
FR-IN-31



MUTAJ 4A
FR-IN-32



MUTAJ 4B
FR-IN-33



TRANSPORTO





TRANSPORTO Series

Vehicles are very popular toys found on playgrounds all around the world. Every child can take on the role of a driver, captain, pilot, or astronaut. The TRANSPORTO series stimulates imagination and offers many opportunities for play..

Serie TRANSPORTO

Fahrzeuge sind sehr beliebte Spielzeuge, die auf Spielplätzen auf der ganzen Welt zu finden sind. Jedes Kind kann in die Rolle eines Fahrers, Kapitäns, Piloten oder Astronauten schlüpfen. Die TRANSPORTO-Serie regt die Fantasie an und bietet zahlreiche Spielmöglichkeiten.

HDPE and HPL panels give the toy its shape and character.

HDPE- und HPL-Platten verleihen dem Spielgerät Form und Charakter.

The powder-coated steel structure ensures safety during play.

Die Konstruktion aus Edelstahl oder pulverbeschichtetem Stahl sorgt für Sicherheit beim Spielen.

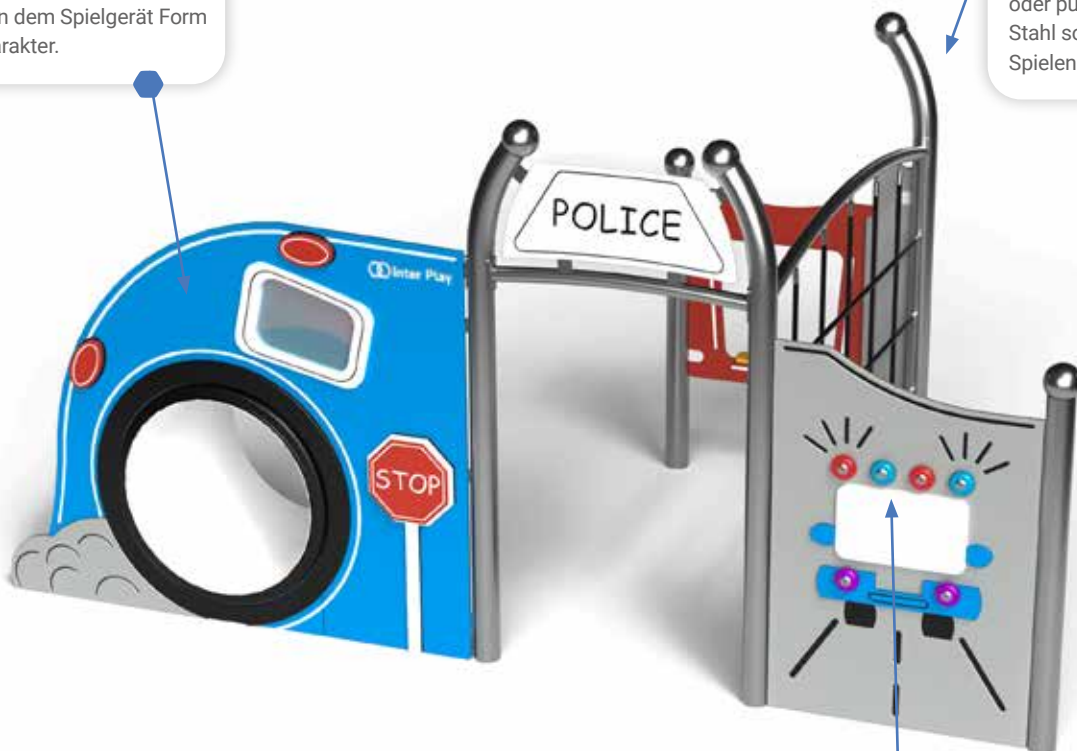

Interactive elements enhance the fun.

Interaktive Elemente erhöhen den Spielspaß und die Attraktivität des Spielgeräts.



**FARM
BAUERNHOF**
01-TR-701



**HARBOUR
HAFEN**
01-TR-702



**POLICE STATION
POLIZEI-STATION**
01-TR-703



FARM, BAUERNHOF	01-TR-701	3,27 x 1,73 x 1,58	6,26 x 4,72	1,28	1+	10
HARBOUR, HAFEN	01-TR-702	3,68 x 1,73 x 1,58	6,65 x 4,71	1,28	1+	10
POLICE STATION, POLIZEI-STATION	01-TR-703	3,17 x 1,73 x 1,58	6,16 x 4,71	1,28	1+	10

monto





Embankment slides and tunnels | Hangrutschen und Kriechtunnel

Option I - straight entrance tunnel (Kanalo).
Option II - sloped entrance tunnel (Tunelo).

Variante I - Eingang senkrecht geschnitten (Kanalo).
Variante II - Eingang schräg geschnitten (Tunelo)

Stainless steel.
Edelstahl.

Option I - narrow slide (Gliti).
Option II - wide slide (Eliri).

Variante I - schmale Rutsche (Gliti).
Variante II - breite Rutsche (Eliri).

Different lengths of tunnels.

Mehrere Tunnellängen.



Different lengths of slides.
Mehrere Rutschenlängen.

Rail slides. | Doppelrutschstange.

Foundations.
Fundamente.



Any number of handrails available.
Beliebige Anzahl der Handläufen

Different lengths of slides.
Mehrere Rutschenlängen.

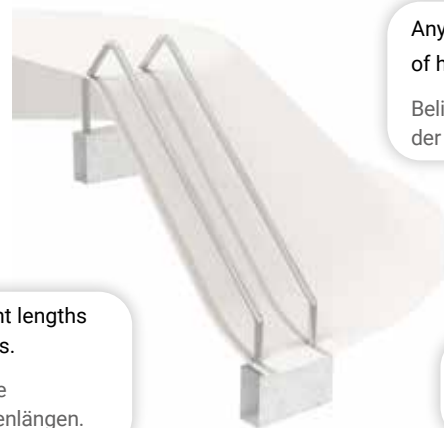

Stainless steel.
Edelstahl.

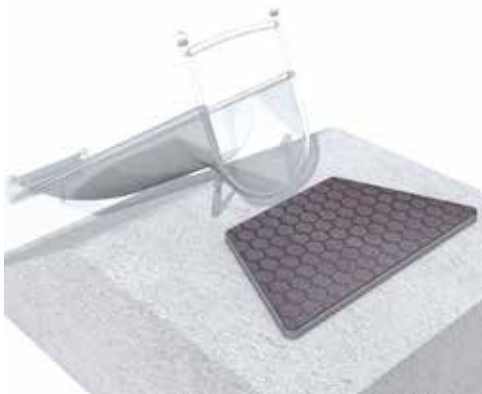

Multiple colors
Mehrere Farben

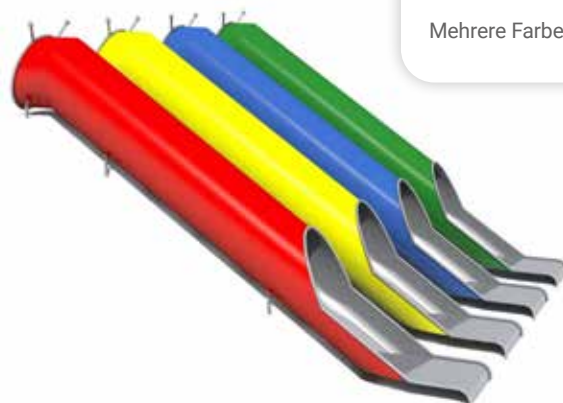

The starting platform eliminates dirt on the slide.
Additionally, it protects the surface from wear.

Die Startplattform entfernt Schmutz von der Rutsche.
Zudem schützt sie den Untergrund vor Abnutzung.



GLITI**ELIRI****RELO****GLITI-S****TUBO****GLITI INCLUSIVE****GLITI RACE****GLITI / ELIRI / RELO / GLITI RACE / TUBO / GLITI INCLUSIVE - parameters**

PRODUCT PRODUKT	CODE	L1 - EMBANKMENT HEIGHT L1 - BÖSCHUNGS- HÖHE	L2 - EMBANKMENT LENGTH L2 - BÖSCHUNGS- LÄNGE	A - SAFETY ZONE A - SICHERHEITS- ZONE
GLITI H825 ELIRI H825 RELO H825 GLITI H825 RACE	LL-MO-001 LL-MO-021 LL-MO-101 01-MO-371	600-825	1475	1500
GLITI H1000 ELIRI H1000 RELO H1000 GLITI H1000 RACE	LL-MO-007 LL-MO-027 LL-MO-107 01-MO-372	775-1000	1788	1500
GLITI H1350 ELIRI H1350 RELO H1350 GLITI H1350 RACE TUBO H1350	LL-MO-002 LL-MO-022 LL-MO-102 01-MO-373 IS-MO-505	950-1350	2414	2000
GLITI H1700 ELIRI H1700 RELO H1700 GLITI H1700 RACE TUBO H1700 GLITI H1700 INCLUSIVE	LL-MO-003 LL-MO-023 LL-MO-103 01-MO-374 IS-MO-501 01-MO-361	1300-1700	3040	2000

PRODUCT PRODUKT	CODE	L1 - EMBANKMENT HEIGHT L1 - BÖSCHUNGS- HÖHE	L2 - EMBANKMENT LENGTH L2 - BÖSCHUNGS- LÄNGE	A - SAFETY ZONE A - SICHERHEITS- ZONE
GLITI H2050 ELIRI H2050 RELO H2050 GLITI H2050 RACE TUBO H2050 GLITI H2050 INCLUSIVE	LL-MO-004 LL-MO-024 LL-MO-104 01-MO-375 IS-MO-502 01-MO-362	1650-2050	3666	2000
GLITI H2400 ELIRI H2400 RELO H2400 GLITI H2400 RACE TUBO H2400 GLITI H2400 INCLUSIVE	LL-MO-008 LL-MO-028 LL-MO-108 01-MO-376 IS-MO-506 01-MO-363"	2000-2400	4292	2000
GLITI H2750 ELIRI H2750 RELO H2750 GLITI H2750 RACE TUBO H2750 GLITI H2750 INCLUSIVE	LL-MO-005 LL-MO-025 LL-MO-105 01-MO-377 IS-MO-503 01-MO-364	2350-2750	4918	2000
GLITI H3100 ELIRI H3100 RELO H3100 GLITI H3100 RACE TUBO H3100 GLITI H3100 INCLUSIVE	LL-MO-006 LL-MO-026 LL-MO-106 01-MO-378 IS-MO-504 01-MO-365	2700-3100	5544	2000
GLITI-S H3600	IS-MO-401	3100-3500	6259	2000
GLITI-S H4100	IS-MO-402	3600-4000	7153	2000
GLITI-S H4600	IS-MO-403	4100-4500	8047	2000
GLITI-S H5100	IS-MO-404	4600-5000	8941	2000

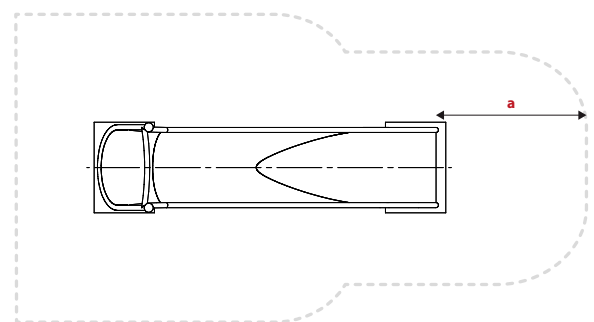
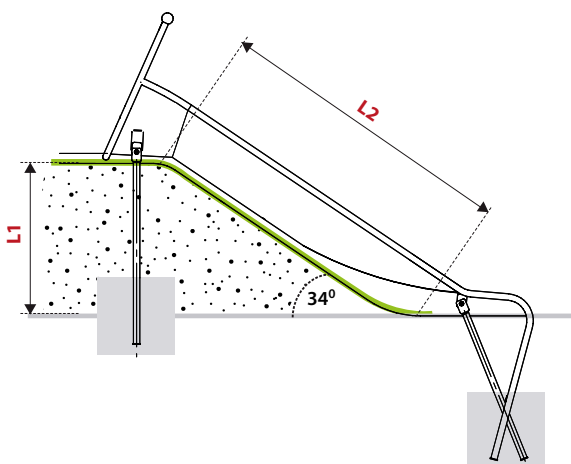

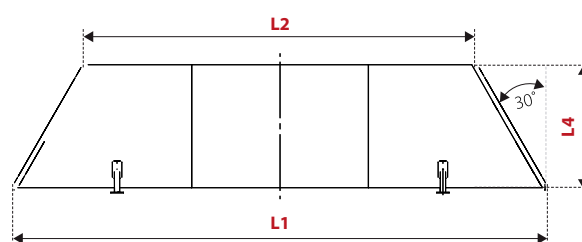
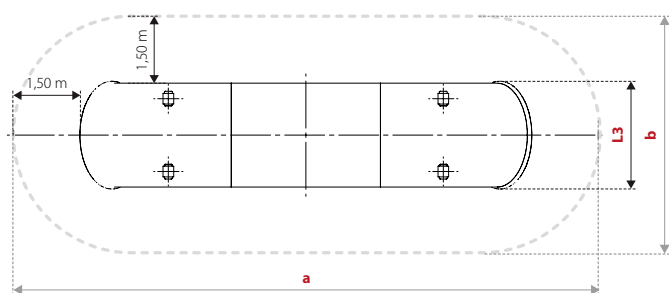
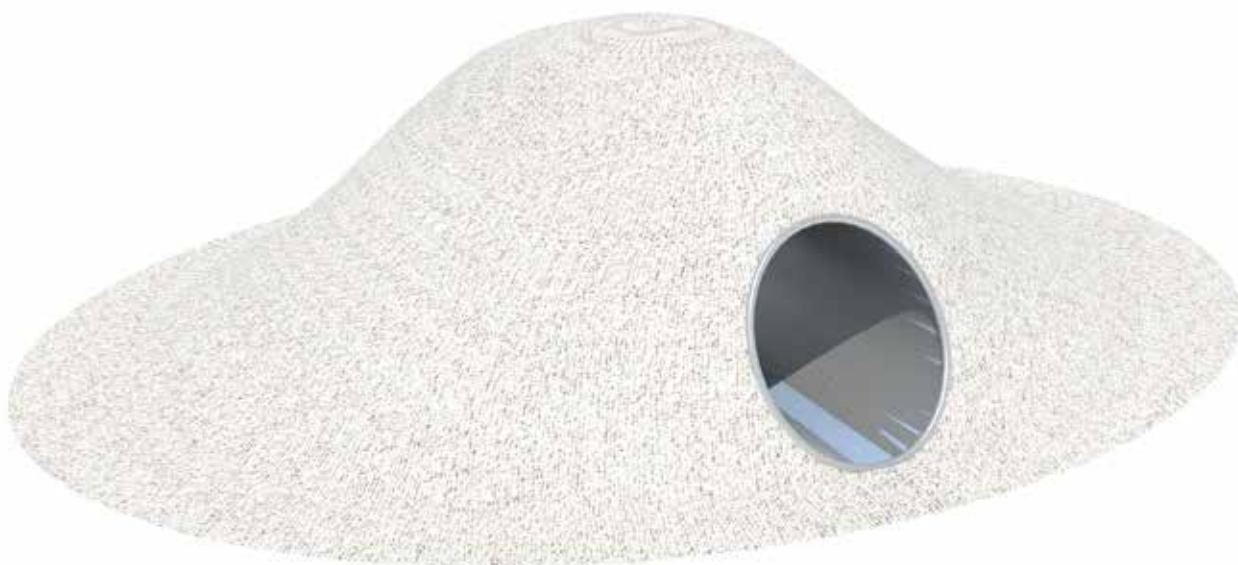

TUNELO

PRODUCT PRODUKT	CODE CODE	L1	L2	L3	L4	AxB
TUNELO 200	LL-MO-202	2,90 m	2,00 m	0,85 m	0,78 m	5,90 x 3,85 m
TUNELO 250	LL-MO-204	3,40 m	2,50 m	0,85 m	0,78 m	6,40 x 3,85 m
TUNELO 300	LL-MO-206	3,90 m	3,00 m	0,85 m	0,78 m	6,90 x 3,85 m
TUNELO 350	LL-MO-208	4,40 m	3,50 m	0,85 m	0,78 m	7,40 x 3,85 m
TUNELO 400	LL-MO-210	4,90 m	4,00 m	0,85 m	0,78 m	7,90 x 3,85 m
TUNELO 450	LL-MO-212	5,40 m	4,50 m	0,85 m	0,78 m	8,40 x 3,85 m
TUNELO 500	LL-MO-214	5,90 m	5,00 m	0,85 m	0,78 m	8,90 x 3,85 m

L1 - total length | Gesamtlänge

L2 - total length | Gesamtlänge

L3 - total width | Gesamtbreite

L4 - inner diameter | Innendurchmesser







A, B - safety zone | Sicherheitszone



FRABINA 1200
IS-MO-601

FRABINA 1600
IS-MO-602

FRABINA 2000
IS-MO-603

						
FRABINA H 1,2 M	IS-MO-601	3,37 x 0,59 x 1,95 m	6,87 x 3,57 m	1,20 m	3+	1
FRABINA H 1,6 M	IS-MO-602	4,04 x 0,59 x 2,35 m	7,54 x 3,57 m	1,60 m	3+	1
FRABINA H 2,0 M	IS-MO-603	4,79 x 0,59 x 2,75 m	8,29 x 3,57 m	200 m	3+	1

PARK





Cubic-shaped playgrounds, light in the form. Spielplätze mit einfachem, leichtem Design.

Quick and easy installation.

Einfache und schnelle
Montage.

The walls are made of HDPE boards, which are resistant to intensive use and are easy to clean. Their vivid colors underline the aesthetic value of the playground.

Die Anlagewände sind aus HDPE-Platten hergestellt, die bei intensiver Nutzung nicht verschleifen und leicht zu reinigen sind. Ihre lebendigen Farben betonen den ästhetischen Wert des Spielplatzes.

Galvanized and powder painted steel resistant to rust.

Verzinkter, pulverbeschichteter
Stahl.

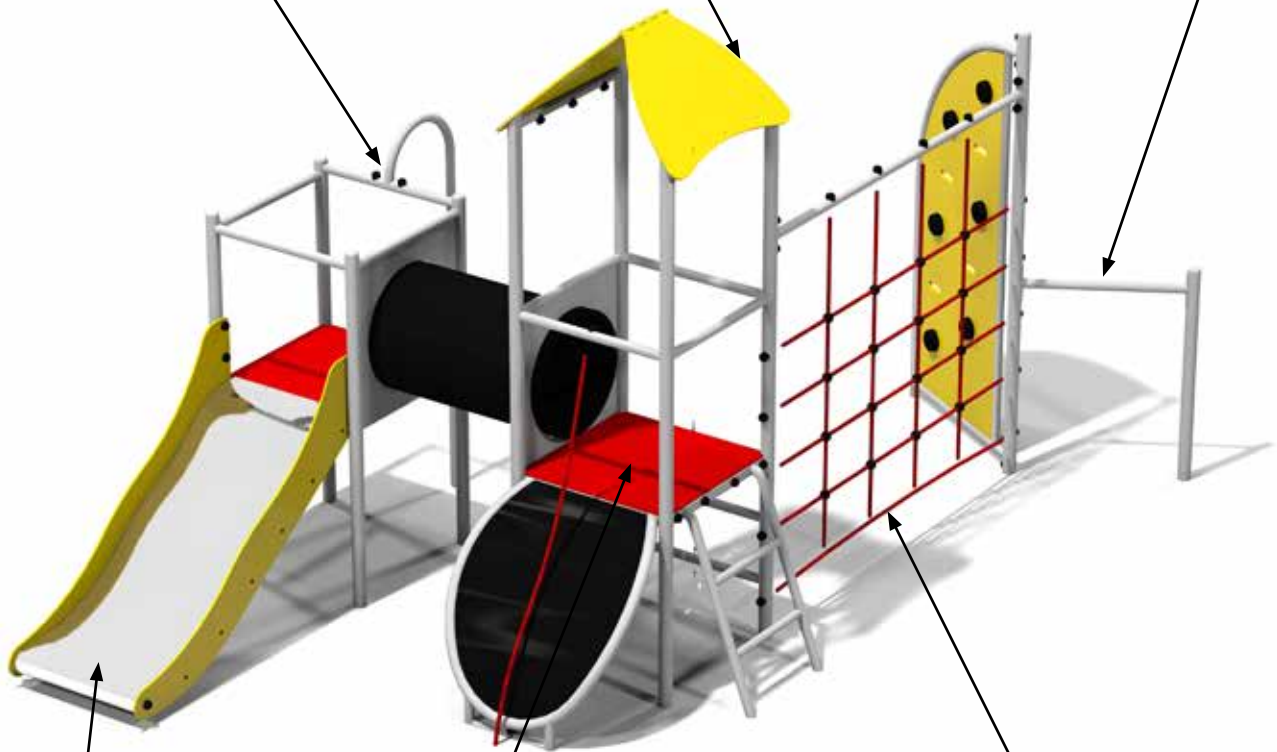

Wave-shaped slide
guarantees great fun..

Wellenförmige Rutsche
gewährleistet mehr
Spaß beim Spielen.

PE panels with a non-slip structure ensure safety and limit the possibility of uncontrolled slipping during play.

PE-Kunststoffplatten mit einer rutschfesten Struktur gewährleisten die Sicherheit und begrenzen die Möglichkeit des unkontrollierten Rutschens während des Spiels.

Durable polypropylene ropes are reinforced with a steel cores to ensure safety while playing.

Langlebige Polypropylen-Seile, sind mit einem Stahlkern verstärkt und sorgen für Sicherheit beim Spielen.

Play units | Spielanlagen



Swings | Schaukeln



Hammocks and Seesaws | Hängematten und Wippe



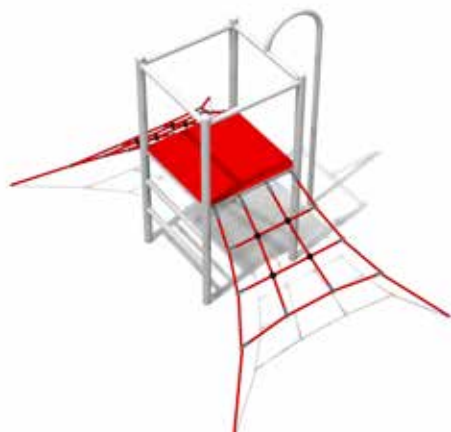

CACTUS 1
GM41413-T

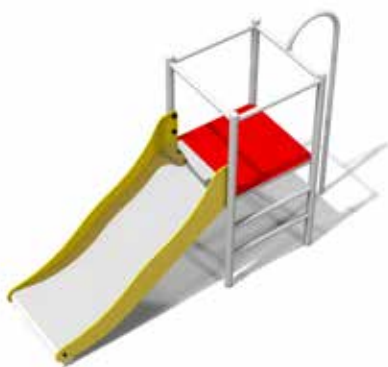

CACTUS 2
GM41411-T

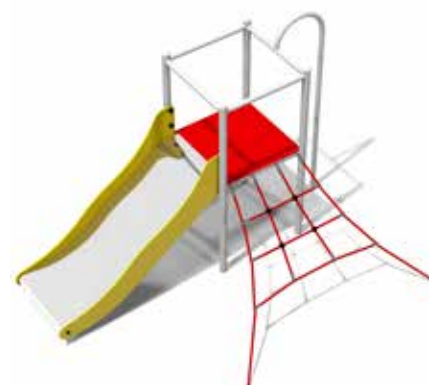

CACTUS 3
GM41412-T



BLUEBELL
GK-PA-103



BERGAMOT
GK-PA-101



CACTUS 1	GM41413-T	2,93 x 1,84 x 1,80	5,97 x 4,83	0,90	3+	4
CACTUS 2	GM41411-T	2,68 x 0,81 x 1,80	6,20 x 3,79	0,90	3+	2
JASMINE	GM41423-T	3,63 x 2,93 x 1,80	6,66 x 6,44	1,80	3+	8
CACTUS 3	GM41412-T	2,77 x 1,87 x 1,80	6,26 x 4,88	0,90	3+	3
DAISY	GM424401-T	4,33 x 2,25 x 1,80	7,38 x 5,75	0,90	3+	7
BERGAMOT	GK-PA-101	3,77 x 3,29 x 2,86	6,77 x 6,79	0,90	3+	7
MARIGOLD	GK-PA-102	6,98 x 2,85 x 2,86	10,98 x 5,85	1,26	3+	6
BLUEBELL	GK-PA-103	5,83 x 4,24 x 3,22	9,31 x 7,21	1,95	3+	13



MARIGOLD
GK-PA-102



JASMINE
GM41423-T

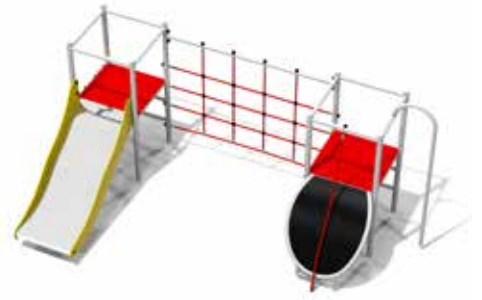

DAISY
GM424401-T





LILAC
GK-PA-105



PANSY
GK-PA-106



POPPY
GK-PA-104



PETUNIA
GK-PA-107



CAMELLIA
GM424402-T



GERBERA
GM444401-T



LILAC	GK-PA-105	5,97 x 4,58 x 3,22	9,47 x 7,58	1,95	3+	13
PANSY	GK-PA-106	6,98 x 4,28 x 2,86	10,98 x 7,28	1,95	3+	12
POPPY	GK-PA-104	6,15 x 5,00 x 2,86	9,65 x 8,00	1,50	3+	9
PETUNIA	GK-PA-107	6,78 x 4,72 x 3,22	10,28 x 7,82	1,95	3+	18
CAMELLIA	GM424402-T	4,70 x 3,09 x 2,86	8,19 x 6,07	2,00	3+	10
GERBERA	GM444401-T	5,83 x 5,42 x 3,22	8,84 x 8,90	2,00	3+	20
MARIGOLD	GK-PA-102	6,98 x 2,85 x 2,86	10,98 x 5,85	1,26	3+	6
BLUEBELL	GK-PA-103	5,83 x 4,24 x 3,22	9,31 x 7,21	1,95	3+	13



AKRA





Bridges and rope tunnels made of strong polyamide rope.

Kletterbrücken und Tunnel sind aus starkem Polyamid-Seil gefertigt.

Tunnels made of polypropylene.

Tunnel aus Polypropylen.

Funny graphics on roofs and side panels.

Fröhliche Kindermotive auf den Dächern und Seitenpaneelen.



Structure made of stable, metal profiles.

Stabile Konstruktion aus Stahl.

Colorful polyethylene slides are protected against heating.

Bunte PE-Rutschen werden nie heiß.

Extremely durable HPL platform board is equipped with non-slip structure that ensures safety and limits possibility of uncontrolled slippage during play.

Langlebige HPL-Platte mit einer rutschfesten Struktur gewährleistet die Sicherheit und begrenzt die Möglichkeit des unkontrollierten Rutschens während des Spiels.

AVELO

For children 3-6 years old

Für 3-6 jährige Kinder

**PIRO**

For children under 3 years old

Für Kinder unter 3 Jahren





AVELO 4-2
BO-AK-542







AVELO 4-3
BO-AK-543



AVELO 3-5
BO-AK-535



AVELO 3-3
BO-AK-533

						
AVELO 4-2	BO-AK-542	5,37 x 4,64 x 3,11	8,87 x 8,14	1,94	3+	12
AVELO 4-3	BO-AK-543	7,64 x 5,37 x 3,11	11,64 x 8,87	1,94	3+	12
AVELO 3-5	BO-AK-535	5,61 x 3,11 x 3,11	8,61 x 6,61	1,20	3+	10
AVELO 3-3	BO-AK-533	4,95 x 4,07 x 3,11	7,95 x 8,07	1,20	3+	9
AVELO 3-4	BO-AK-534	5,37 x 3,24 x 3,11	8,87 x 6,24	1,20	3+	11
AVELO 2-4	BO-AK-524	4,75 x 3,42 x 3,11	8,75 x 6,42	1,20	3+	6



AVELO 3-4
BO-AK-534



AVELO 2-4
BO-AK-524





AVELO 2-3
BO-AK-523



AVELO 2-5
BO-AK-525



AVELO 1-2
BO-AK-512









AVELO 1-3
BO-AK-513



PIRO 4-1
BO-AK-541



PIRO 3-1
BO-AK-531

							
AVELO 2-3	BO-AK-523	4,07 x 3,42 x 3,11	8,07 x 6,42	1,94	3+	4	
AVELO 2-5	BO-AK-525	4,79 x 1,31 x 3,11	8,29 x 4,31	1,20	3+	5	
AVELO 1-2	BO-AK-512	2,82 x 0,78 x 1,72	6,32 x 3,78	0,90	3+	2	
AVELO 1-3	BO-AK-513	2,75 x 1,82 x 3,11	6,25 x 4,82	1,20	3+	2	
PIRO 4-1	BO-AK-541	4,83 x 2,99 x 2,25	8,83 x 5,99	1,33	1+	9	
PIRO 3-2	BO-AK-532	4,27 x 2,99 x 2,25	7,77 x 5,99	1,33	1+	6	
PIRO 3-1	BO-AK-531	6,31 x 0,92 x 2,25	9,83 x 3,93	0,59	1+	6	
PIRO 2-1	BO-AK-521	4,27 x 0,92 x 2,25	7,77 x 3,92	0,59	1+	3	
PIRO 2-2	BO-AK-522	3,93 x 1,29 x 2,25	7,43 x 4,29	0,59	1+	4	
PIRO 1-1	BO-AK-511	2,23 x 0,92 x 2,25	5,73 x 3,93	0,59	1+	2	



PIRO 3-2
BO-AK-532



PIRO 2-1
BO-AK-521



PIRO 2-2
BO-AK-522



PIRO 1-1
BO-AK-511



 Robinia





Wood type ROBINIA

Beams approximately 16 cm thick. The hardwood is very durable and thus does not require frequent repairs. The natural appearance makes play even more attractive.

Robinienholz

Balken mit einer Dicke von ca. 16 cm. Das Hartholz ist sehr langlebig und erfordert daher keine häufigen Reparaturen. Das natürliche Aussehen macht das Spielen noch attraktiver.

HDPE Board

Decorations made from colorful 15mm thick board. They give an attractive appearance reminiscent of forest motifs.

HDPE-Platte

Dekorationen aus einer 15 mm dicken, bunten Platte. Sie verleihen ein attraktives Aussehen, das an Waldmotive erinnert.

Wood Connectors

All wooden elements are joined together with stainless connectors.

Holzverbinder

Alle Holzelemente sind mit rostfreien Verbindern miteinander verbunden.

Ropes

6-strand ropes with an internal steel core for enhanced durability.

Seile

6-strängige Seile mit einem inneren Stahldrahtkern für erhöhte Haltbarkeit.

Stainless Steel

The slide and bars are made of stainless steel. The elements are durable and very aesthetically pleasing

Edelstahl

Die Rutsche und Stangen sind aus Edelstahl gefertigt. Die Elemente sind langlebig und sehr ästhetisch.



The hardwood ROBINIA is very durable and therefore does not require frequent repairs.

Hartholz ROBINIA ist sehr langlebig und erfordert daher keine häufigen Reparaturen.

The natural appearance of the wood ensures that play is even more attractive.

Das natürliche Aussehen des Holzes sorgt dafür, dass das Spielen noch attraktiver wird.

The wood we use is sourced from plantations with FSC certification.

Das von uns verwendete Holz stammt aus Plantagen mit FSC-Zertifizierung.





ROBINIA 1
02-ROB-700



ROBINIA 2
02-ROB-701



ROBINIA 3
02-ROB-702



ROBINIA 4
02-ROB-703



ROBINIA 1	02-ROB-700	3,75 x 4,20 x 4,25	7,25 x 7,20	90,00	3-12	10
ROBINIA 2	02-ROB-701	3,60 x 4,42 x 4,25	6,60 x 7,92	120,00	3-12	10
ROBINIA 3	02-ROB-702	5,25 x 9,00 x 4,80	8,75 x 12,00	200,00	3-12	16
ROBINIA 4	02-ROB-703	9,40 x 6,42 x 4,50	13,00 x 9,92	210,00	3-12	25
ROBINIA 5	02-ROB-200-N	2,38 x 3,21 x 2,48	7,50 x 2,35	137,00	3-12	2
ROBINIA 8	02-ROB-203-BS	2,38 x 3,89 x 2,48	7,50 x 3,17	134,00	3-12	2
ROBINIA 9	02-ROB-204-NS	2,38 x 4,46 x 2,48	7,50 x 5,25	137,00	3-12	2
ROBINIA 11	02-ROB-650	0,73 x 3,00 x 1,05	2,73 x 4,91	90,00	3-12	2
ROBINIA 12	02-ROB-600	0,32 x 0,95 x 0,86	2,32 x 3,55	58,00	1-12	1



ROBINIA 5
02-ROB-200-N



ROBINIA 8
02-ROB-203-BS



ROBINIA 9
02-ROB-204-NS

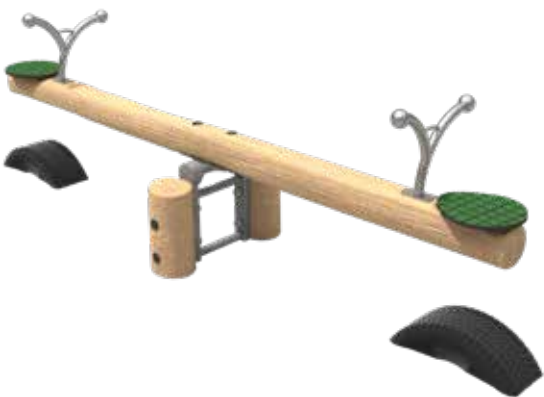

ROBINIA 11
02-ROB-650



ROBINIA 12
02-ROB-600



ROBINIA 13
02-ROB-1100



ROBINIA 14
BO-DR-102



ROBINIA 21
02-ROB-1103



ROBINIA 18
02-ROB-706



ROBINIA 19
02-ROB-707



ROBINIA 20
02-ROB-708



ROBINIA 13	02-ROB-1100	2,75 x 2,75 x 0,60	5,75 x 5,75	60,00	3-12	8
ROBINIA 14	02-ROB-1101	2,52 x 2,52 x 4,80	5,86 x 5,86	99,00	3-12	12
ROBINIA 15	02-ROB-704	9,87 x 4,60 x 4,45	12,87 x 8,30	201,00	3-12	18
ROBINIA 16	02-ROB-1102	5,33 x 5,33 x 4,80	8,47 x 8,47	170,00	3-12	25
ROBINIA 17	02-ROB-705	2,75 x 9,60 x 4,80	5,75 x 12,60	80,00	3-12	20
ROBINIA 18	02-ROB-706	1,45 x 3,60 x 3,60	4,45 x 6,60	60,00	3-12	8
ROBINIA 19	02-ROB-707	3,80 x 0,45 x 4,80	6,80 x 3,45	150,00	3-12	3
ROBINIA 20	02-ROB-708	2,20 x 1,85 x 3,60	5,20 x 4,85	100,00	3-12	4
ROBINIA 21	02-ROB-1103	2,05 x 3,45 x 1,91	5,45 x 6,85	180,00	3-12	4

ROBINIA 17
02-ROB-705



ROBINIA 16
02-ROB-1102

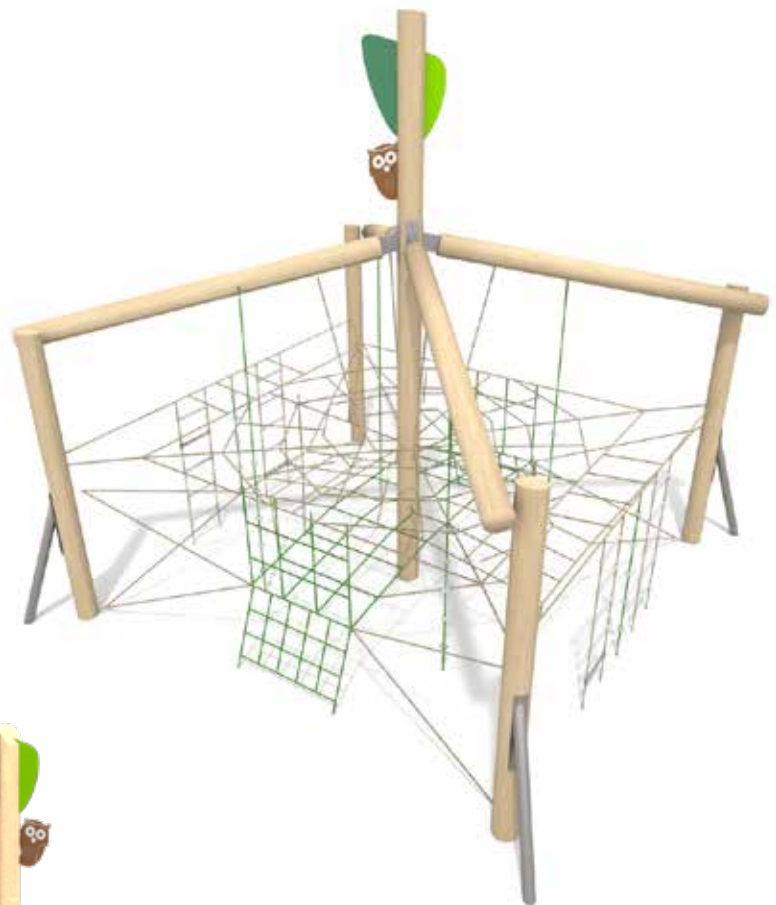

ROBINIA 15
02-ROB-704

dog agility

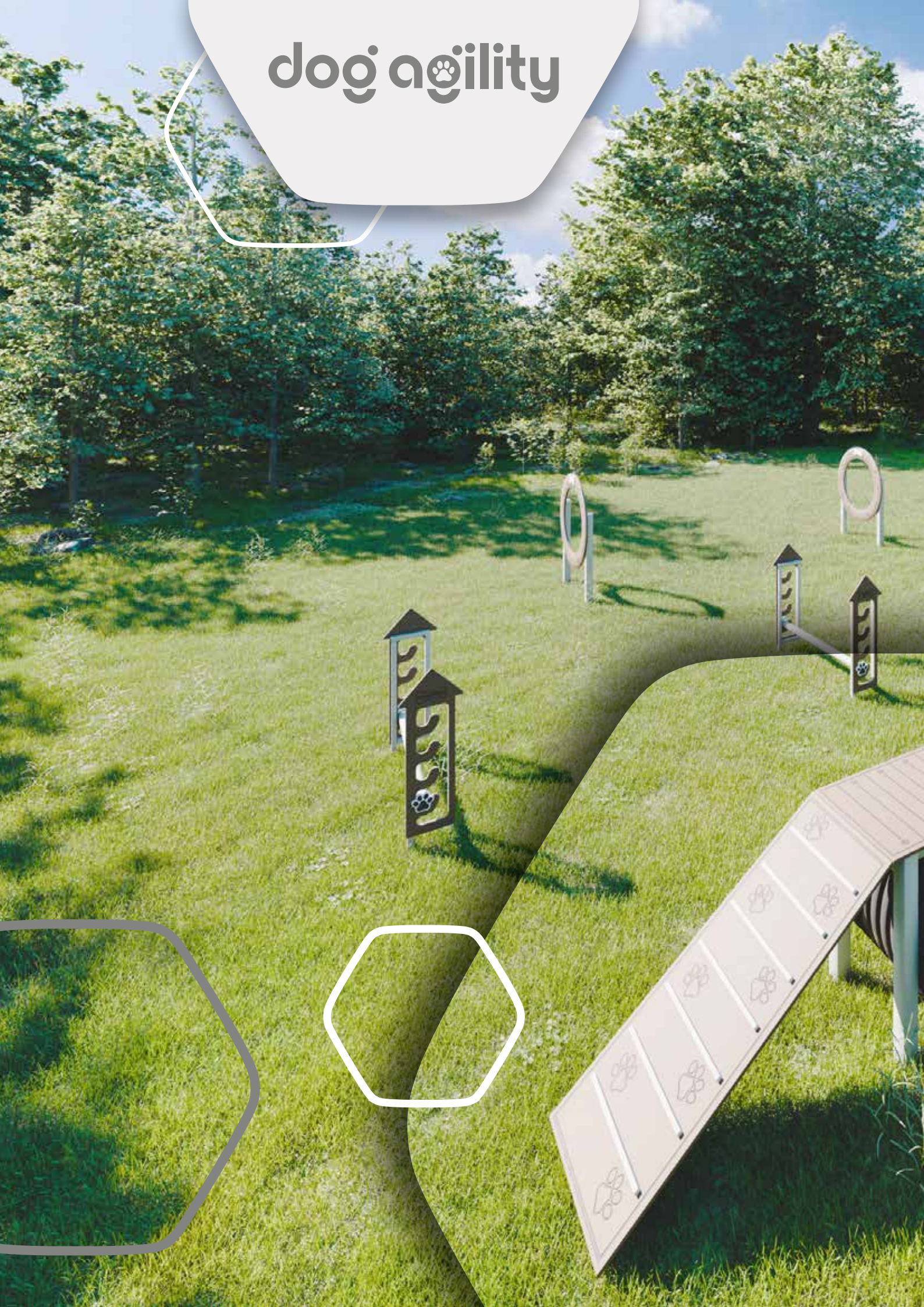

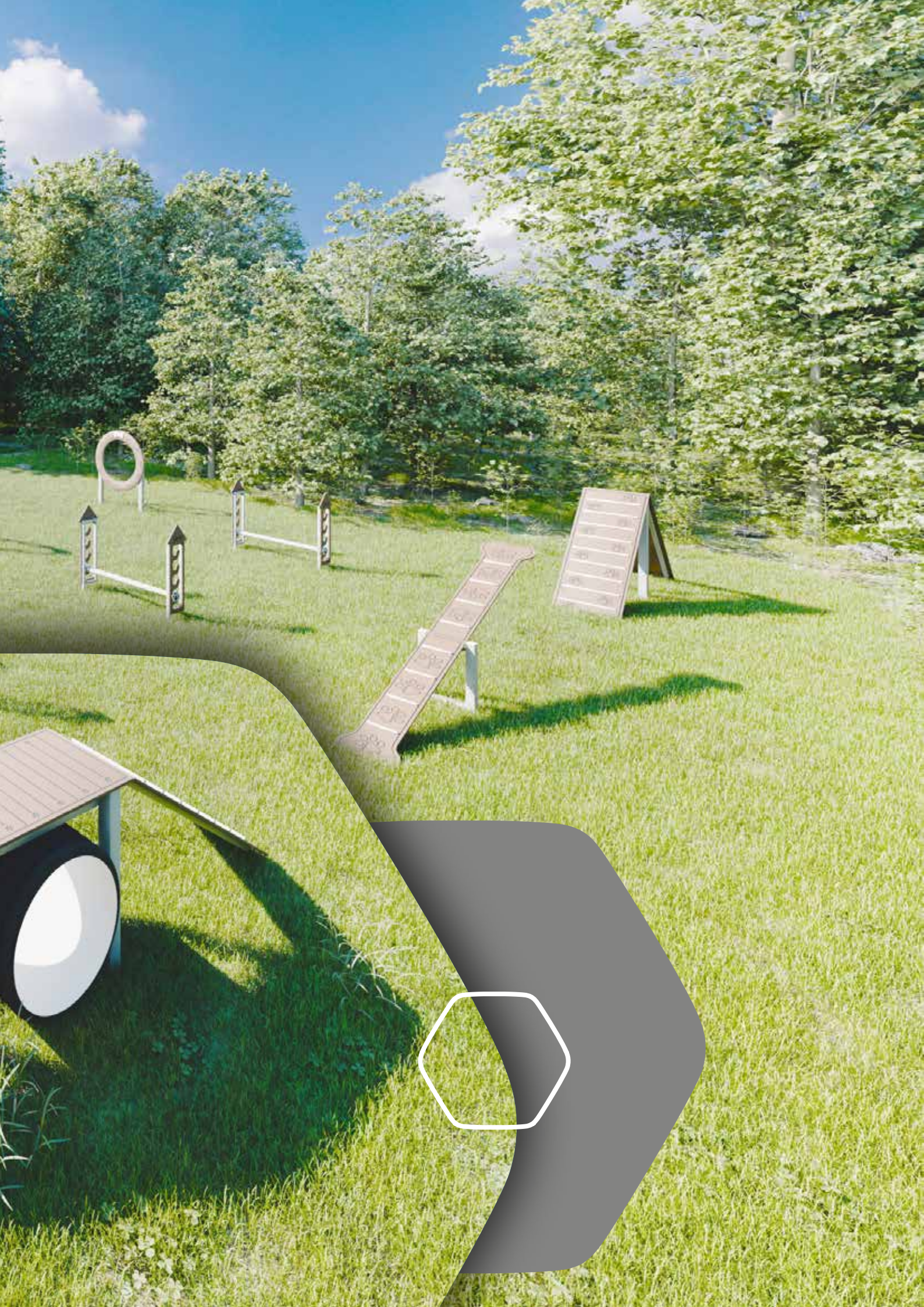

DOG AGILITY Series

Especially for all dogs, we have created the DOG AGILITY series. Thanks to it, you can create a fantastic space where dogs can play and exercise. Additionally, dog owners meet each other and have a great time together.

We have made sure that our offer includes most of the exercises and obstacles that such a facility should be equipped with.

Serie DOG AGILITY

Speziell für alle Hunde haben wir die Serie DOG AGILITY entwickelt. So kann ein fantastischer Bereich geschaffen werden, in dem Hunde spielen und trainieren können. Zusätzlich treffen sich die Hundebesitzer, um gemeinsam eine schöne Zeit zu verbringen.

Wir haben darauf geachtet, dass unser Angebot die meisten Übungen und Hindernisse umfasst, die eine solche Anlage unbedingt haben sollte.

For the comfort of the animals, we utilized natural, wood-like coloring.

Für den Komfort der Tiere haben wir eine natürliche Farbgebung verwendet, die an Holz erinnert.

The individual play functions were consulted with dog training specialists.

Die einzelnen Spiel- und Trainingsfunktionen wurden mit Hundetrainern abgestimmt.



The toys' surface is decorated with attractive motifs, making the whole product look beautiful.

Die Oberfläche der Spielgeräte ist mit attraktiven Motiven dekoriert, wodurch das Gesamtbild besonders ansprechend wirkt.





DOG AGILITY 1
01-DA-3900



DOG AGILITY 2
01-DA-3901



DOG AGILITY 3
01-DA-3902



DOG AGILITY 4
01-DA-3903



DOG AGILITY 5
01-DA-3904



DOG AGILITY 6
01-DA-3905



DOG AGILITY 1	01-DA-3900	3,85 x 0,55 x 1,18
DOG AGILITY 2	01-DA-3901	3,40 x 1,47 x 2,35
DOG AGILITY 3	01-DA-3902	1,32 x 1,47 x 1,67
DOG AGILITY 4	01-DA-3903	1,98 x 1,47 x 1,67
DOG AGILITY 5	01-DA-3904	3,15 x 0,55 x 0,79
DOG AGILITY 6	01-DA-3905	1,05 x 0,10 x 1,37
DOG AGILITY 7	01-DA-3906	1,44 x 0,71 x 0,45
DOG AGILITY 8	01-DA-3907	3,20 x 0,90 x 0,66
DOG AGILITY 9	01-DA-3908	2,36 x 0,55 x 1,18
DOG AGILITY 10	01-DA-3909	3,64 x 0,35 x 0,95
DOG AGILITY 11	01-DA-3910	4,18 x 3,15 x 2,20
DOG AGILITY 12	01-DA-3911	2,4 x 0,10 x 0,89
DOG AGILITY 13	01-DA-3912	0,75 x 0,75 x 0,31
DOG AGILITY 14	01-DA-3913	3,00 x 0,50 x 0,72
DOG AGILITY 15	01-DA-3914	0,75 x 0,75 x 0,18
DOG AGILITY 16	01-DA-3915	1,23 x 0,32 x 1,00
DOG AGILITY 17	01-DA-3916	1,00 x 1,00 x 0,46



DOG AGILITY 7
01-DA-3906



DOG AGILITY 8
01-DA-3907



DOG AGILITY 9
01-DA-3908



DOG AGILITY 10
01-DA-3909



DOG AGILITY 11
01-DA-3910



DOG AGILITY 12
01-DA-3911



DOG AGILITY 13
01-DA-3912



DOG AGILITY 14
01-DA-3913



DOG AGILITY 15
01-DA-3914



DOG AGILITY 16
01-DA-3915



DOG AGILITY 17
01-DA-3916



OUTDOOR GAMES

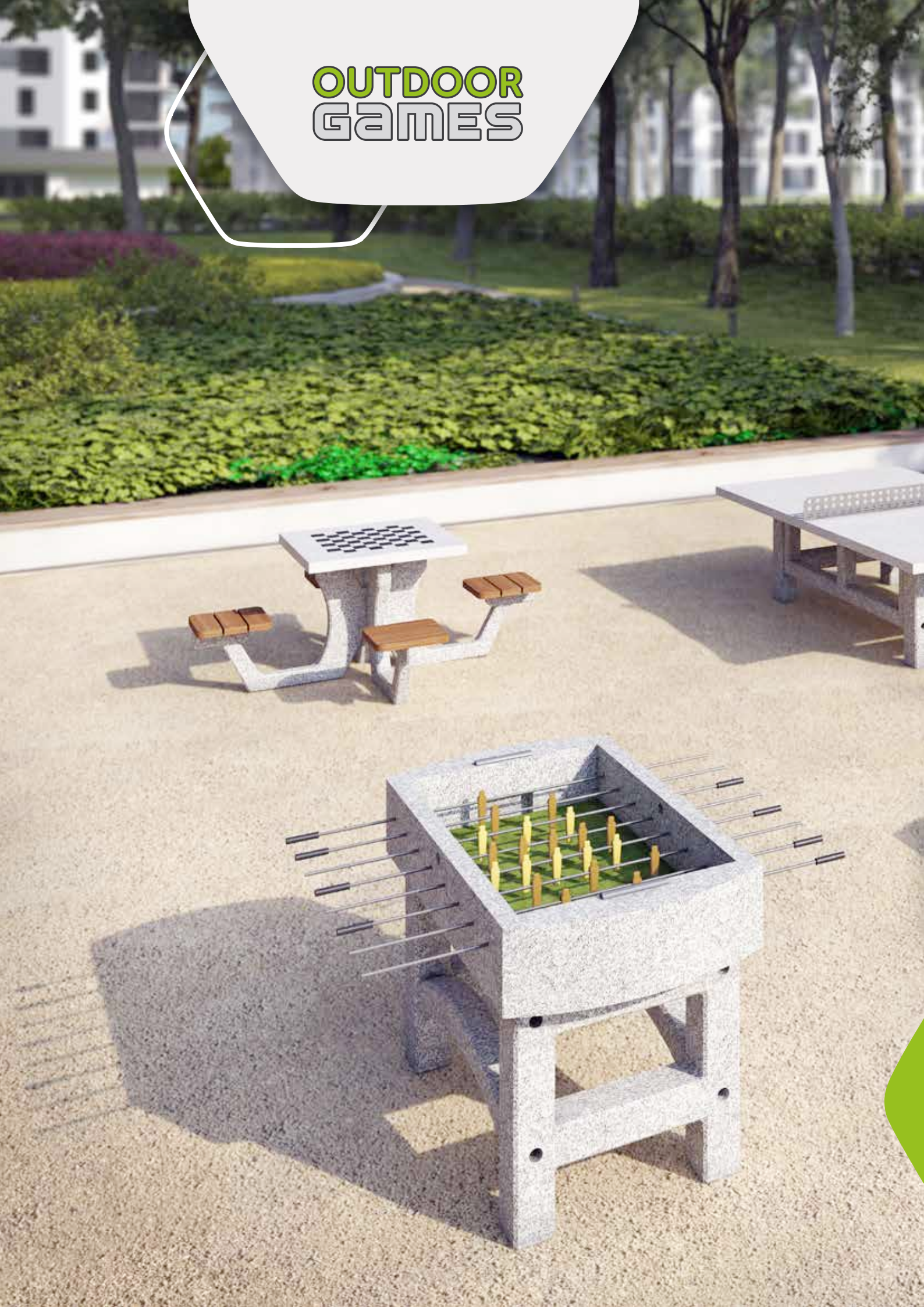





TENNIS TABLE 01/02
TISCHTENNISPLATTE 01/02
KT-02-CR-007/008

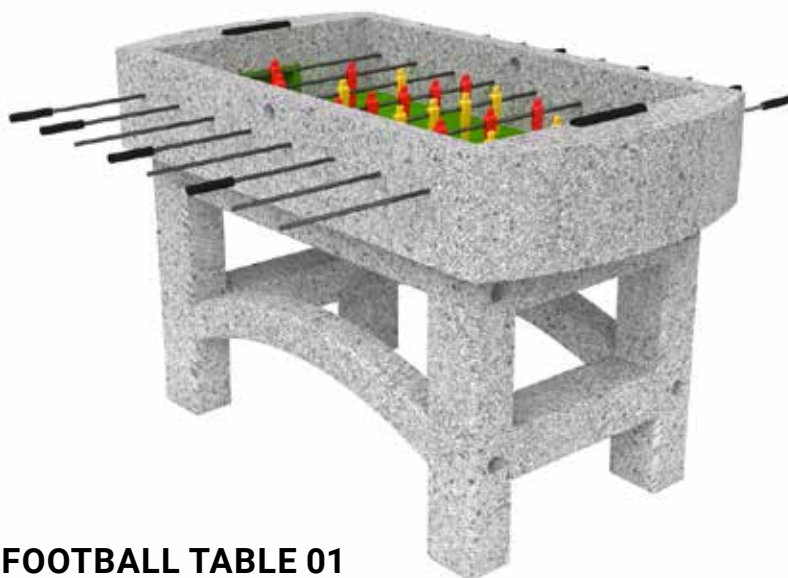

FOOTBALL TABLE 01
KICKERTISCH 01
KT-02-CR-009



TENNIS TABLE 01/02

KT-02-CR-007/008

2,74 x 1,52 x 0,78

FOOTBALL TABLE 01

KT-02-CR-009

1,52 x 0,80 x 0,88

TABLE FOR CHESS - CHECKERS 01

KT-02-CR-001

2,00 x 2,00 x 0,81

PICNIC TABLE 01

KT-02-CR-011

2,00 x 2,00 x 0,81

PICNIC TABLE 02

KT-02-CR-012

2,00 x 2,00 x 0,78

Concrete games tables | Spieltische aus Beton



**TABLE FOR CHESS -
CHECKERS 01**
KT-02-CR-001



TABLE FOR LUDO GAME 01
KT-02-CR-002



PICNIC TABLE 01
KT-02-CR-011



PICNIC TABLE 02
KT-02-CR-012



**TABLE FOR CHESS - CHECKERS 03**

T-02-CR-005

**PICNIC TABLE 03**

KT-02-CR-013

**TABLE FOR LUDO GAME 03**

KT-02-CR-006



TABLE FOR CHESS - CHECKERS 03	KT-02-CR-005	2,00 x 2,00 x 0,83	-
PICNIC TABLE 03	KT-02-CR-013	2,00 x 2,00 x 0,83	-
TABLE FOR LUDO GAME 03	KT-02-CR-006	2,00 x 2,00 x 0,83	-
TABLE FOR CHESS - CHECKERS / LUDO GAME	KT-02-CR-010	2,00 x 2,00 x 0,78	-
TABLE FOR CHESS - CHECKERS 02	KT-02-CR-003	2,00 x 2,00 x 0,78	-
TABLE FOR LUDO GAME 02	KT-02-CR-004	2,00 x 2,00 x 0,78	-



**TABLE FOR CHESS -
CHECKERS / LUDO GAME 02**
KT-02-CR-010



TABLE FOR CHESS - CHECKERS 02
KT-02-CR-003



TABLE FOR LUDO GAME 02
KT-02-CR-004

URBAN FURNITURE





TOPAZO

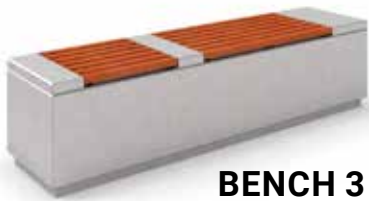

BENCH 3



BENCH 2



BENCH 4



BENCH 1

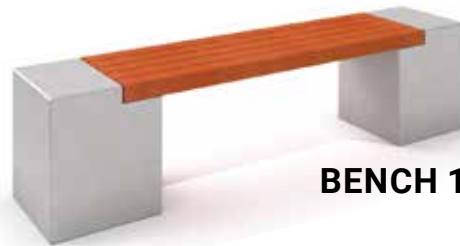

BENCH 11



BENCH 5



BENCH 7



TRASH BIN 5



ARMITA



BENCH 9

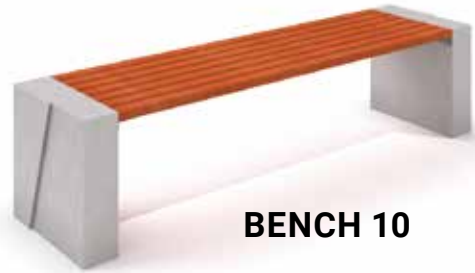

BENCH 10

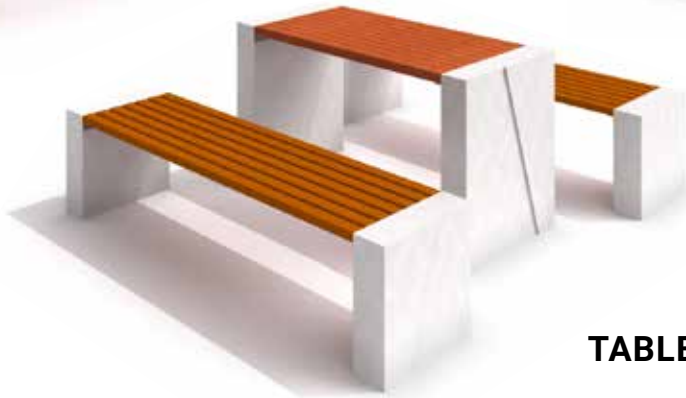

TABLE 2



TRASH BIN 1



KRETO



BENCH 5



BENCH 6



TRASH BIN 7

PERLO

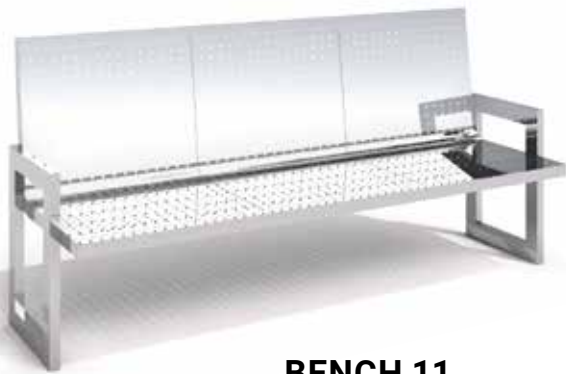

BENCH 11

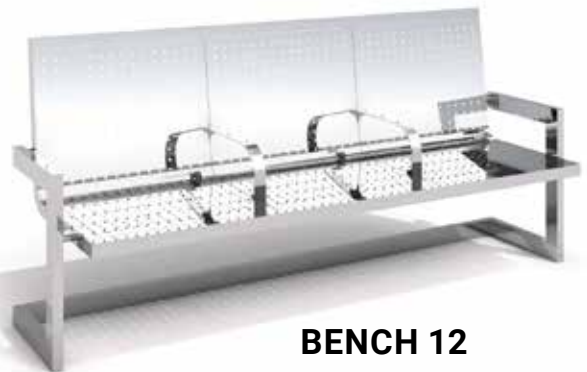

BENCH 12



BICYCLE RACK 24



TRASH BIN 6

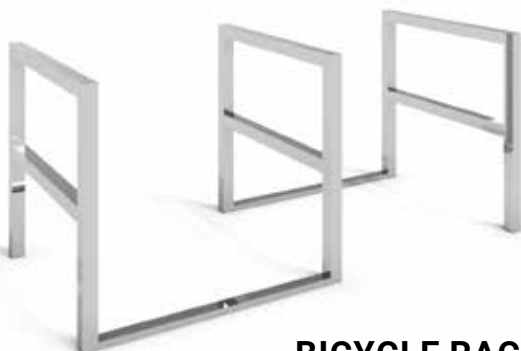

BICYCLE RACK 6



TRASH BIN 7

MALAKITO

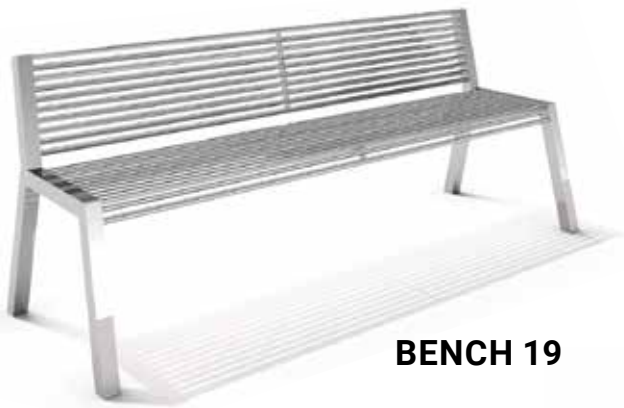

BENCH 19



BENCH 20



TRASH BIN 4



JAGO



BENCH 16



BENCH 17

TRASH BIN 7



TRASH BIN 5

TRASH BIN 6



BICYCLE RACK 8



BICYCLE RACK 10



BICYCLE RACK 26

SAFIRO



BENCH 5



BENCH 6



BENCH 7



TRASH BIN 1



TRASH BIN 2



BICYCLE RACK 6

KRONO



BENCH 21



BENCH 15



BENCH 3



BICYCLE RACK 2



BICYCLE RACK 8



BICYCLE RACK 1



Benches made of Deco concrete | Sitzbänke aus Dekobeton



DECO CONCRETE BENCH 1



DECO CONCRETE BENCH 2



DECO CONCRETE BENCH 3



DECO CONCRETE BENCH 4



DECO CONCRETE BENCH 5



DECO CONCRETE BENCH 6



DECO CONCRETE BENCH 7



DECO CONCRETE BENCH 8



DECO CONCRETE BENCH 9



DECO CONCRETE BENCH 10



DECO CONCRETE BENCH 11



DECO CONCRETE BENCH 12



DECO CONCRETE BENCH 13



DECO CONCRETE BENCH 14

Concrete benches | Sitzbänke aus gewaschenem Beton



CONCRETE BENCH 1



CONCRETE BENCH 2



CONCRETE BENCH 5



CONCRETE BENCH 6



CONCRETE BENCH 7



CONCRETE BENCH 8



CONCRETE BENCH 9



CONCRETE BENCH 3



CONCRETE PLANTER SET WITH BENCH 1



CONCRETE PLANTER SET WITH BENCH 2



CONCRETE PLANTER SET WITH BENCH 3



CONCRETE BENCH 4



CONCRETE PLANTER SET WITH BENCH 1



CONCRETE PLANTER SET WITH BENCH 2



CONCRETE PLANTER SET WITH BENCH 3

Stainless steel and steel benches | Edelstahl Sitzbänke



STAINLESS STEEL BENCH 1



STAINLESS STEEL BENCH 2



STAINLESS STEEL BENCH 3



STAINLESS STEEL BENCH 4



STAINLESS STEEL BENCH 5



STAINLESS STEEL BENCH 6



STAINLESS STEEL BENCH 7



STAINLESS STEEL BENCH 8



STAINLESS STEEL BENCH 9



STAINLESS STEEL BENCH 10



STAINLESS STEEL BENCH 11



STAINLESS STEEL BENCH 12



STAINLESS STEEL BENCH 13



STAINLESS STEEL BENCH 14



STAINLESS STEEL BENCH 15



STAINLESS STEEL BENCH 16



STAINLESS STEEL BENCH 17



STAINLESS STEEL BENCH 18



STAINLESS STEEL BENCH 19



STAINLESS STEEL BENCH 20



STAINLESS STEEL BENCH 21



Decorative trash bins made of Deco concrete | Mülleimer aus Dekobeton



DECO WHITE CONCRETE TRASH BIN 1



DECO WHITE CONCRETE TRASH BIN 2

Concrete trash bins | Mülleimer aus gewaschenem Beton



CONCRETE TRASH BIN 1



CONCRETE TRASH BIN 2



CONCRETE TRASH BIN 3



CONCRETE TRASH BIN 4



CONCRETE TRASH BIN 5



CONCRETE TRASH BIN 6



CONCRETE TRASH BIN 7

Stainless steel and steel trash bins | Edelstahl Mülleimer



STAINLESS STEEL TRASH BIN 8



STAINLESS STEEL TRASH BIN 1



STAINLESS STEEL TRASH BIN 2



STAINLESS STEEL TRASH BIN 3



STAINLESS STEEL TRASH BIN 4



STAINLESS STEEL TRASH BIN 5



STAINLESS STEEL TRASH BIN 6



STAINLESS STEEL TRASH BIN 7



Stainless steel and steel bicycle racks | Edelstahl Fahrradständer



**STAINLESS STEEL
BICYCLE RACK 1**



**STAINLESS STEEL
BICYCLE RACK 2**



**STAINLESS STEEL
BICYCLE RACK 4**



**STAINLESS STEEL
BICYCLE RACK 5**



**STAINLESS STEEL
BICYCLE RACK 6**



**STAINLESS STEEL
BICYCLE RACK 7**



**STAINLESS STEEL
BICYCLE RACK 8**



**STAINLESS STEEL
BICYCLE RACK 10**



**STAINLESS STEEL
BICYCLE RACK 11**



**STAINLESS STEEL
BICYCLE RACK 12**



**STAINLESS STEEL
BICYCLE RACK 13**



**STAINLESS STEEL
BICYCLE RACK 14**

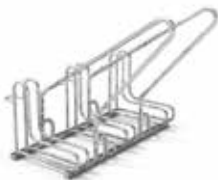

**STAINLESS STEEL
BICYCLE RACK 15**



**STAINLESS STEEL
BICYCLE RACK 16**

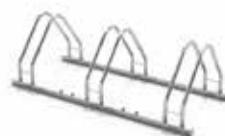

**STAINLESS STEEL
BICYCLE RACK 17**



**STAINLESS STEEL
BICYCLE RACK 18**

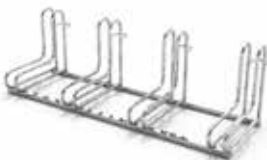

**STAINLESS STEEL
BICYCLE RACK 19**



**STAINLESS STEEL
BICYCLE RACK 20**

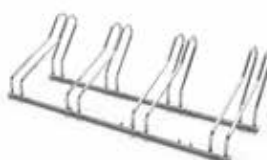

**STAINLESS STEEL
BICYCLE RACK 21**



**STAINLESS STEEL
BICYCLE RACK 22**



**STAINLESS STEEL
BICYCLE RACK 24**



**STAINLESS STEEL
BICYCLE RACK 25**



**STAINLESS STEEL
BICYCLE RACK 26**



A VOTRE SERVICE DEPUIS 1995



English

direction@healthsport.ch

+41 21 903 57 67

<https://healthsport.ch/>

Deutschland / Österreich

direction@healthsport.ch

+41 21 903 57 67

<https://healthsport.ch/>