



A VOTRE SERVICE DEPUIS 1995

2026



EXPERIENCE

Over 20 years of market experience.

We operate in 57 countries.

Successful co-operation with numerous customers around the world.

ERFAHRUNG

Über 20 Jahre Markterfahrung.

Unsere Produkte machen Spaß in 52 Ländern.

Erfolgreiche Zusammenarbeit mit vielen Kunden aus der ganzen Welt.

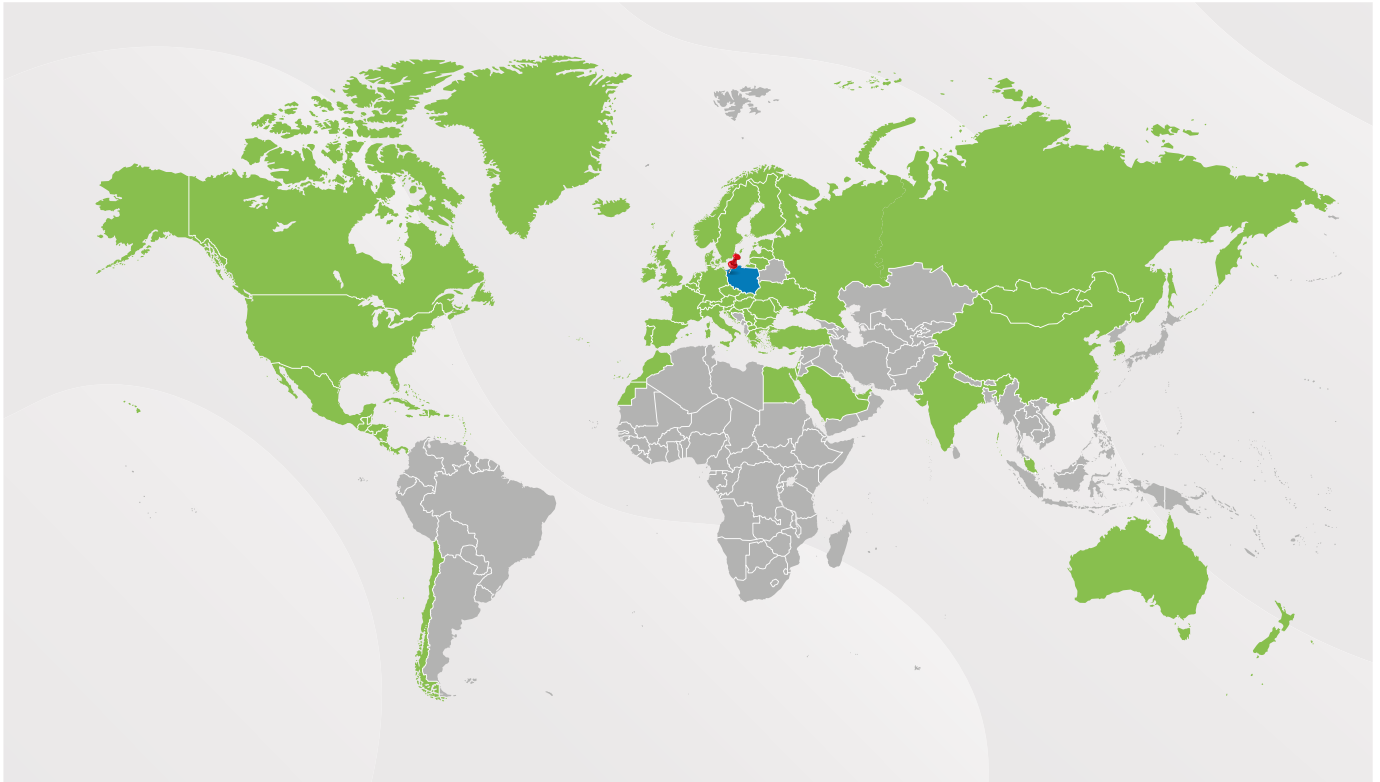

OFFER | ANGEBOT



SFERO
LIMAKO
LUMO PLAY
SALTO
INTEGRADO
LINARIUM
TRANSPORTO
MONTA
ROTO
PARK
AKRA
ROBINIA
DOG AGILITY



SPEED
FITNESS
STREET WORKOUT
NINJA PARK
ARENAS
OUTDOOR GAMES



COLLECTIONS
BENCHES
TRASH BINS
BICYCLE RACKS

Order our catalogue:

direction@healthsport.ch
sales@healthsport.ch

Sie können den Katalog in Papierform bestellen:

direction@healthsport.ch
sales@healthsport.ch

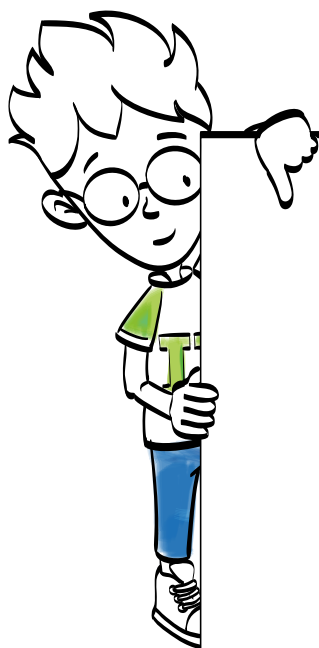

Please contact us:

- ✉ direction@healthsport.ch
- ☎ +41 21 903 57 67
- 🌐 <https://healthsport.ch/>

**Zögern Sie sich nicht,
uns zu kontaktieren:**

- ✉ direction@healthsport.ch
- ☎ +41 21 903 57 67
- 🌐 <https://healthsport.ch>

Inter Play Studio

Free online application to design your playground in minutes. Draw or set the size of your plot, drag-and-drop equipment, and preview the layout in 2D or 3D with automatic safety clearances.

Kostenlose Online-Anwendung, um Ihren Spielplatz in wenigen Minuten zu planen. Zeichnen oder definieren Sie die Größe Ihres Grundstücks, platzieren Sie Geräte per Drag-and-drop und sehen Sie die Anordnung in 2D oder 3D – mit automatischen Sicherheitsabständen.

1



Drag-and-drop equipment from our catalogue; filter by function, series, age group, landscape, or surface.

Drag-and-drop oder Belag. von Geräten aus unserem Katalog; Filter nach Funktion, Serie, Altersgruppe, Landschaft

2



Automatic safety zones generated from product specs to help meet standards.

Automatische Sicherheitsbereiche gemäß Produktspezifikationen – zur normgerechten Planung.

3



Save & share visuals for internal approvals and stakeholder presentations.

Speichern & teilen von Visualisierungen für interne Freigaben und Stakeholder-Präsentationen.

Prototype early. Test ideas before detailed design begins.

Früh prototypen. Ideen testen, bevor die Detailplanung startet.

Reduce rework. Safety clearances and space rules are visible from the start.

Nacharbeit reduzieren. Sicherheitsabstände und Flächenregeln sind von Anfang an sichtbar.



Choose smarter. Compare options, swap items, and refine the layout on the fly.

Klüger auswählen. Varianten vergleichen, Geräte tauschen und das Layout spontan verfeinern.



Try this tool on **interplay.eu**

Probieren Sie dieses Werkzeug aus **interplay-spiel.de**





„Now with AI image creation support“

„Jetzt mit Unterstützung von KI-Bilderstellung“

TRAMPOLINE DESIGN STUDIO

Create your unique design on the trampoline.
Based on your project, we will make a trampoline for you.

Erstellen Sie Ihr einzigartiges Design für das Trampolin. Basierend auf Ihrem Projekt werden wir ein Trampolin für Sie anfertigen.

1



Choose trampoline parameters (shape, size, collar color)

Wählen Sie die Trampolinparameter (Form, Größe, Farbe des Kragens)

2



Create a unique, custom trampoline design.

Erstellen Sie ein einzigartiges, individuelles Trampolin-Design.

3



Receive your design at the provided email address. You can order the trampoline production from us.

Erhalten Sie Ihr Design an die angegebene E-Mail-Adresse. Sie können bei uns die Herstellung des Trampolins bestellen.

Possibility to save the project file and return to work on it later.

Möglichkeit, die Projektdatei zu speichern und später weiter daran zu arbeiten.

Choose from various sizes and shapes of trampolines.

Wählen Sie aus verschiedenen Größen und Formen von Trampolinen.

The design of the trampoline is limited only by your imagination.

Das Trampolinmuster ist nur durch Ihre Vorstellungskraft begrenzt.

Wide selection of trampoline lamellas and collar colors.

Große Auswahl an Farben für Lamellen und Trampolinrand.

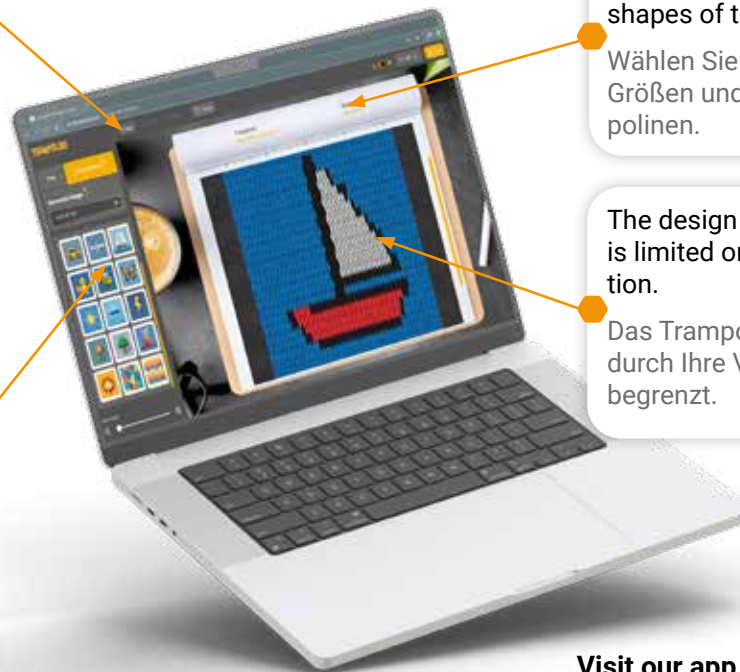

Visit our app

Besuchen Sie unsere App



tdesign-studio.com



SALTO





Trampoline construction | Konstruktion des Trampolins

Construction | Konstruktion

The body of the trampoline is shaped like a chest. It is made of thick welded sheet metal, which provides stability and durability of the trampoline.

Die Konstruktion des Trampolins besteht aus einem geschweißtem, verzinktem Stahlrahmen. Das gewährleistet die richtige Stabilisierung und gewünschte Lebensdauer des Trampolins.

Springs | Federn

Springs are very durable and allow jumping by bending the mat. They have been made to last for years in public facilities.

Die hochqualitative Feder ermöglichen sanftes Springen, ohne ungewünschten Geräuschen. Die Feder wurden so konzipiert, dass sie für den langjährigen Einsatz in den öffentlichen Bereichen geeignet sind.

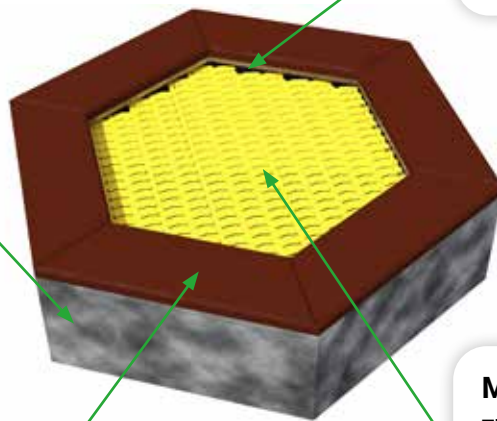
**Elastic collar | Fallschutzumrandung**

Provides security to user and protects against falling outside the jumping area.

Die integrierte, weiche Umrandung sorgt für die Sicherheit der Nutzer. Sie schützt vor den Verletzungen beim Herausfallen aus der Sprungfläche.

Mat | Sprungmatte

The jumping mat is made of very durable lamellas threaded on steel cables. The lamellas have been designed to be durable and reliable, their specific surface prevents slipping.

Die Sprungmatte wird aus langlebigen und wetterfesten Lamellen gefertigt, die auf Stahldrähten aufgefädelt sind. Die Lamellenform verhindert das Brechen. Ihre spezifische Oberfläche schützt vor dem Verrutschen.



Non-slip surface.

Rutschfeste Oberfläche.

The wide lamella wings provide greater comfort when jumping.

Die breiten Lamellenflügel sorgen für besseren Komfort beim Springen.

Very durable, thick and strong bushings with high resistance for exploitation.

Dicke, sehr starke und langlebige Buchsen mit hoher Verschleißfestigkeit.

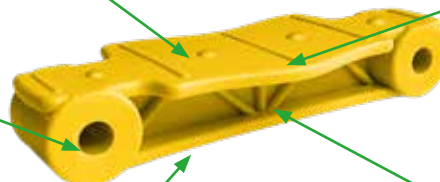

The lamellas are extremely durable thanks to specially designed reinforcements.

Die Lamellen sind dank speziell entwickelter Verstärkungen extrem langlebig.

Thanks to the unique shape of the lamellas, the space between them has been reduced to only 7 mm. This prevents small items such as keys or cell phones from falling inside the trampoline.

Dank der einzigartigen Form der Lamellen wurde der Innenabstand auf nur 7 mm reduziert. Dadurch wird verhindert, dass kleine Dinge wie Schlüssel oder Handys in das Trampolin fallen.

Trampoline construction | Konstruktion des Trampolins

Construction | Konstruktion

The Trampoline body is embedded directly in the ground. It is very stable and durable due to anti corrosion protection by hot - dip galvanizing.

Das Trampolin wird als ein Element in den Boden eingesetzt. Seine solide Konstruktion und Langlebigkeit verdankt es der Feuerverzinkung.

Safe surface | Sicherheitsbereich

There should be a safe surface around the trampoline to protect children from falls.

Um das Trampolin herum sollte ein sicherer Bodenbelag vorhanden sein, der die Kinder vor Sturzfolgen schützt.

Hardened ground | Befestigter Untergrund

The trampoline is directly mounted on the hardened and levelled ground, which needs to be permeable to water.

Das Trampolin soll direkt auf den befestigten, stabilen Untergrund gesetzt werden. Der Untergrund muss wasserdurchlässig sein.

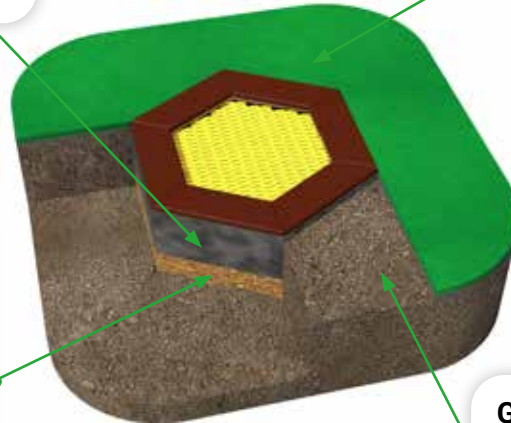

Ground | Boden

The trampoline is installed in the ground at a depth of 40 cm.

Das Trampolin soll in eine Grubentiefe von 40 cm eingesetzt werden.

Cleaning the inside of the trampoline | Reinigung des Inneraums

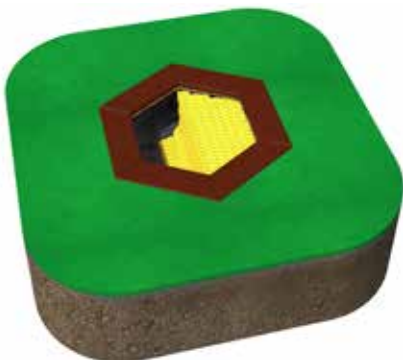

Variant I - removing the mat

Variante I - Entfernung der Sprungmatte

To clean the trampoline you need to remove part of the jumping mat. Removing the mat is simple and involves sliding the rope shackles from the springs located along the perimeter of the body of the trampoline.

Um das Trampolin zu reinigen, muss man ein Teil der Sprungmatte entfernen. Um die Sprungmatte zu entfernen, sollen die Seilschäkel von den Federn weggeschoben werden. Die Federn befinden sich auf dem Umfang der Konstruktion.



Variant II - opening the cover

Variante II - Eröffnung des Hebedeckels

Once you open the cover of the trampoline, you can simply clean its inside.

Das Trampolin kann auch durch die einfache Eröffnung von Hebedeckels gereinigt werden.

The colours of the lamellas | Lamellenfarben



black | schwarz
RAL 9005

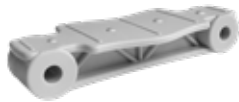

gray | grau
RAL 7035



green | grün
RAL 6029



red | rot
RAL 3020



blue | blau
RAL 5005



pastel blue | pastellblau
RAL 5024



yellow | gelb
RAL 1018



orange | orange
RAL 2005

Patterns on the jumping mat | Sprungmattenmotive

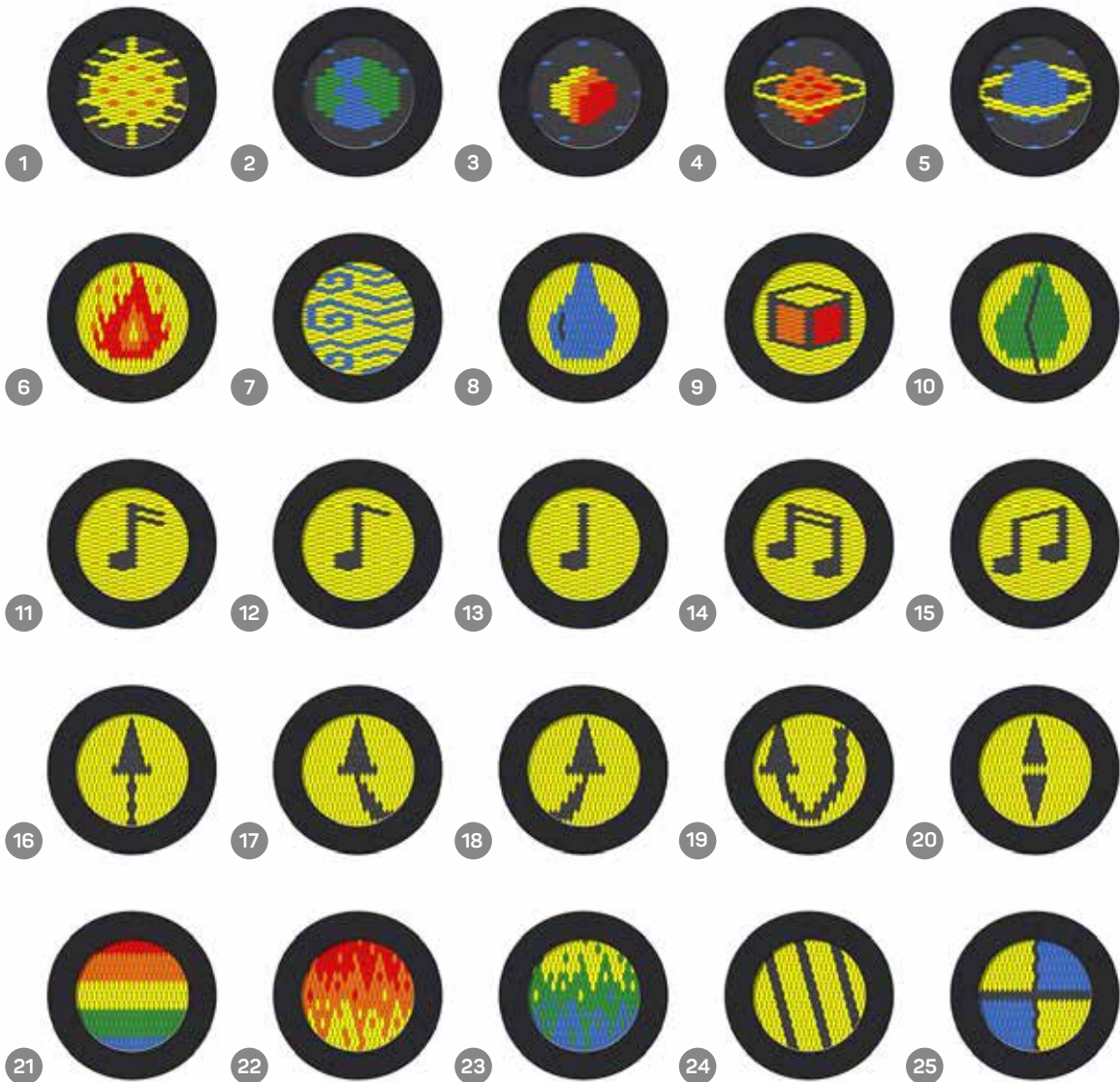

Elastic collar colours | Farben Umrandungsfarben

SBR



red
rot

black
schwarz

EPDM



DESIGN YOUR TRAMPOLINE | GESTALTEN SIE IHR TRAMPOLIN

Create your own unique trampoline - choose a color, pattern, shape and size.

Erstellen Sie Ihr eigenes einzigartiges Trampolin - wählen Sie Farbe, Muster, Form und Größe aus.



TRAMPOLINE

DESIGN STUDIO

Create your unique design on the trampoline.
Based on your project, we will make
a trampoline for you.

Erstellen Sie Ihr einzigartiges Design für das
Trampolin. Basierend auf Ihrem Projekt werden
wir ein Trampolin für Sie anfertigen.

1



Choose trampoline parameters
(shape, size, collar color)

Wählen Sie die Trampolinparameter
(Form, Größe, Farbe des Kragens)

2



Create a unique, custom
trampoline design.

Erstellen Sie ein einzigartiges,
individuelles Trampolin-
Design.

3



Receive your design at the provided email ad-
dress. You can order the trampoline production
from us.

Erhalten Sie Ihr Design an die angegebene E-Mail-
Adresse. Sie können bei uns die Herstellung des
Trampolins bestellen.

Visit our app

Besuchen Sie unsere App

tdesign-studio.com



„Now with AI image creation
support”

„Jetzt mit Unterstützung von
KI-Bilderstellung”

Do you want a trampoline that captivates with its unique design? Discover the Trampoline Design Studio - an innovative tool that allows you to create a trampoline mat with your own one-of-a-kind pattern.

Träumst du von einem Trampolin, das mit seinem einzigartigen Design beeindruckt? Entdecke das Trampolin Design Studio - ein innovatives Online-Werkzeug, das die Erstellung der Trampolinmatte mit eigenem, einzigartigem Muster ermöglicht.

Possibility to save the project file and return to work on it later.

Möglichkeit, die Projektdatei zu speichern und später weiter daran zu arbeiten.

Choose from various sizes and shapes of trampolines.

Wählen Sie aus verschiedenen Größen und Formen von Trampolinen.

The design of the trampoline is limited only by your imagination.

Das Trampolinmuster ist nur durch Ihre Vorstellungskraft begrenzt.

Wide selection of trampoline lamellas and collar colors.

Große Auswahl an Farben für Lamellen und Trampolinrand.



Visit our app

Besuchen Sie unsere App



tdesign-studio.com

See the unique designs created with the Trampoline Design Studio.

Sehen Sie sich die einzigartigen Designs an, die mit dem Trampoline Design Studio erstellt wurden.



The Trampoline Design Studio is easy to use and intuitive, making it simple to transform a standard trampoline into a distinctive play element.

Das Trampolin Design Studio ist einfach und intuitiv zu bedienen, ermöglicht leicht ein Standardtrampolin in ein einzigartiges Spielelement zu verwandeln.

SALTO trampoline without an elastic collar are adapted to be covered with a safe surface.

Salto Trampolin ohne elastische Umrandung für den fugenlosen Fallschutzbelag.

1 Trampoline without elastic collar ready for surface installation.

Trampolin ohne Fallschutz ist für die Anwendung des fugenlosen Fallschutzbelages bereit.

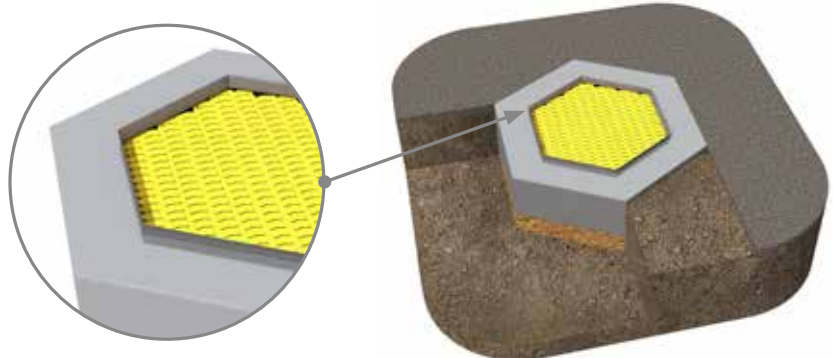

2 Installation of a safe surface using a formwork strip.

Der Ausguß des fugenlosen Fallschutzbelages (vergessen Sie die Schalungsleiste nicht!).

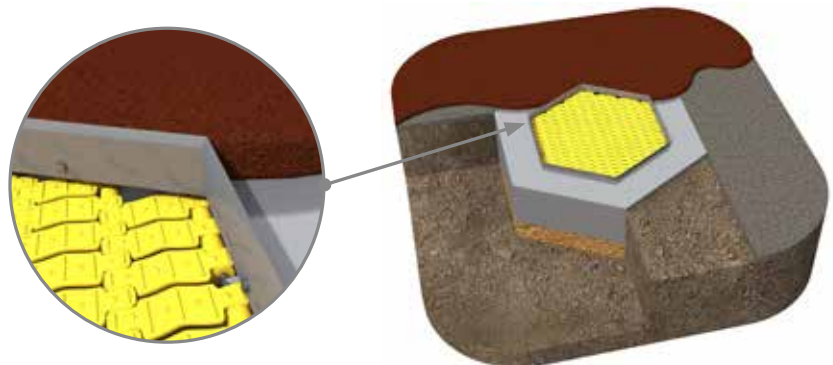

3 The safe surface before removing the formwork strip.

Fertiger Fallschutzbelag vor der Entfernung der Schalungsleiste.

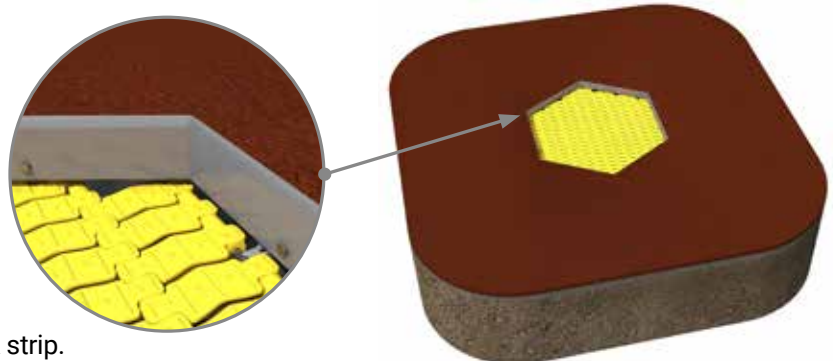

4 Unscrewing and removing the formwork strip.

Die Schalungsleiste kann erst jetzt abgeschraubt und demontiert werden.



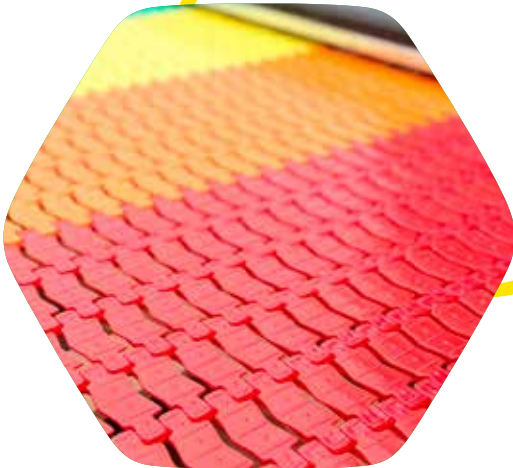

Types of trampolines | Trampolin Arten

Trampoline PAKO

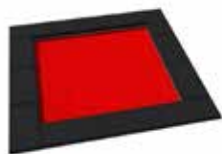

NAME	CODE	A - DIMENSION	B - JUMPING AREA	C - SAFETY AREA
		A - TRAMPOLINGRÖSSE	B - SPRUNGMATTE	C - SICHERHEITSRAUM
PAKO 125	MA-SA-21	1,25 x 1,25 m	0,75 x 0,75 m	3,75 x 3,75 m
PAKO 150	MA-SA-22	1,5 x 1,5 m	1,0 x 1,0 m	4,0 x 4,0 m
PAKO 175	MA-SA-23	1,75 x 1,75 m	1,25 x 1,25 m	5,25 x 5,25 m
PAKO 200	MA-SA-24	2,0 x 2,0 m	1,5 x 1,5 m	5,5 x 5,5 m
PAKO 225	MA-SA-25	2,25 x 2,25 m	1,75 x 1,75 m	5,75 x 5,75 m
PAKO 250	MA-SA-26	2,5 x 2,5 m	2,0 x 2,0 m	6,0 x 6,0 m

Trampoline RADO



NAME	CODE	A - DIMENSION	B - JUMPING AREA	C - SAFETY AREA
		A - TRAMPOLINGRÖSSE	B - SPRUNGMATTE	C - SICHERHEITSRAUM
RADO 125	MA-SA-01	Ø 1,25 m	Ø 0,75 m	Ø 3,75 m
RADO 140	MA-SA-02	Ø 1,4 m	Ø 0,9 m	Ø 3,9 m
RADO 150	MA-SA-03	Ø 1,5 m	Ø 1,0 m	Ø 4,0 m
RADO 160	MA-SA-04	Ø 1,6 m	Ø 1,1 m	Ø 4,1 m
RADO 175	MA-SA-05	Ø 1,75 m	Ø 1,25 m	Ø 4,25 m
RADO 200	MA-SA-06	Ø 2,0 m	Ø 1,5 m	Ø 5,5 m
RADO 225	MA-SA-07	Ø 2,25 m	Ø 1,75 m	Ø 5,75 m

Trampoline ORTA



NAME	CODE	A - DIMENSION	B - JUMPING AREA	C - SAFETY AREA
		A - TRAMPOLINGRÖSSE	B - SPRUNGMATTE	C - SICHERHEITSRAUM
ORTA 125 X 225	MA-SA-40	1,25 x 2,25 m	0,75 x 1,75 m	3,75 x 4,75 m
ORTA 150 X 200	MA-SA-41	1,5 x 2,0 m	1,0 x 1,5 m	5,0 x 5,5 m
ORTA 150 X 225	MA-SA-42	1,5 x 2,25 m	1,0 x 1,75 m	5,0 x 5,75 m
ORTA 150 X 250	MA-SA-43	1,5 x 2,5 m	1,0 x 2,0 m	5,0 x 6,0 m
ORTA 175 X 225	MA-SA-44	1,75 x 2,25 m	1,25 x 1,75 m	5,25 x 5,75 m
ORTA 175 X 250	MA-SA-45	1,75 x 2,5 m	1,25 x 2,0 m	5,25 x 6,0 m
ORTA 150 X 300	MA-SA-46	1,5 x 3,0 m	1,0 x 2,5 m	5,0 x 6,5 m
ORTA 150 x 900	MA-SA-48	1,5 x 9,0 m	1,0 x 8,5 m	5,0 x 12,25 m

Trampoline ORTA-I



integrado



NAME	CODE	A - DIMENSION	B - JUMPING AREA	C - SAFETY AREA
		A - TRAMPOLINGRÖSSE	B - SPRUNGMATTE	C - SICHERHEITSRAUM
ORTA-I 150 X 200	MA-SA-41-I	1,5 x 2,0 m	1,0 x 1,5 m	5,0 x 5,5 m
ORTA-I 150 X 250	MA-SA-43-I	1,5 x 2,5 m	1,0 x 2,0 m	5,0 x 6,0 m
ORTA-I 150 X 300	MA-SA-46-I	1,5 x 3,0 m	1,0 x 2,5 m	5,0 x 6,5 m
ORTA-I 150 X 500	MA-SA-47-I	1,5 x 5,0 m	1,0 x 4,5 m	5,0 x 8,5 m
ORTA-I 150 x 900	MA-SA-48-I	1,5 x 9,0 m	1,0 x 8,25 m	5,0 x 12,25 m

- A** - trampoline dimension
Trampolingröße
- B** - the size of the jumping mat
Größe der Sprungmatte
- C** - safety area
Sicherheitsraum

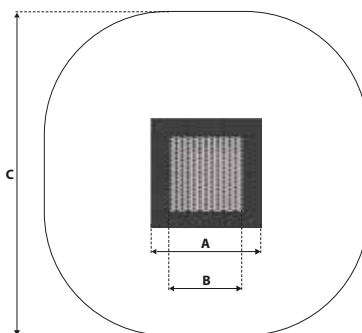

Trampoline **HEXO**

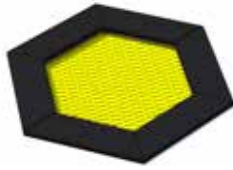

NAME	CODE	A - DIMENSION	B - JUMPING AREA	C - SAFETY AREA
		A - TRAMPOLINGRÖSSE	B - SPRUNGMATTE	C - SICHERHEITSRAUM
HEXO 1	MA-SA-61	1,7 x 1,47 m	1,14 x 0,97 m	4,14 x 3,97 m

Trampoline **PENTO**

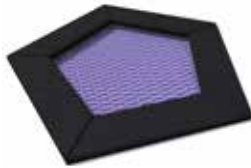

NAME	CODE	A - DIMENSION	B - JUMPING AREA	C - SAFETY AREA
		A - TRAMPOLINGRÖSSE	B - SPRUNGMATTE	C - SICHERHEITSRAUM
PENTO 1	MA-SA-51	1,68 x 1,6 m	1,18 x 1,5 m	4,68 x 4,6 m

Trampoline **KVARTALO**



NAME	CODE	A - DIMENSION	B - JUMPING AREA	C - SAFETY AREA
		A - TRAMPOLINGRÖSSE	B - SPRUNGMATTE	C - SICHERHEITSRAUM
KVARTALO 125	MA-SA-71	1,25 x 1,25 m	0,75 x 0,75 m	3,75 x 3,75 m
KVARTALO 150	MA-SA-72	1,5 x 1,5 m	1,0 x 1,0 m	4,0 x 4,0 m
KVARTALO 175	MA-SA-73	1,75 x 1,75 m	1,25 x 1,25 m	5,25 x 5,25 m
KVARTALO 200	MA-SA-74	2,0 x 2,0 m	1,5 x 1,5 m	5,5 x 5,5 m
KVARTALO 225	MA-SA-75	2,25 x 2,25 m	1,75 x 1,75 m	5,75 x 5,75 m
KVARTALO 250	MA-SA-76	2,5 x 2,5 m	2,0 x 1,0 m	6,0 x 6,0 m

Trampoline **JUNTO**



NAME	CODE	A - DIMENSION	B - JUMPING AREA	C - SAFETY AREA
		A - TRAMPOLINGRÖSSE	B - SPRUNGMATTE	C - SICHERHEITSRAUM
JUNTO 150 x 225	MA-SA-93	1,5 x 2,25 m	1,0 x 1,75 m	4,0 x 4,75 m

Trampoline **DIAMOND**



NAME	CODE	A - DIMENSION	B - JUMPING AREA	C - SAFETY AREA
		A - TRAMPOLINGRÖSSE	B - SPRUNGMATTE	C - SICHERHEITSRAUM
DIAMOND	MA-SA-52	2,37 x 1,3 m	1,55 x 0,8 m	4,55 x 3,8



HEXO 6A
MA-SA-67



HEXO 4A
MA-SA-64



HEXO 3A
MA-SA-62





HEXO 3B
MA-SA-63



HEXO 5A
MA-SA-66



HEXO 4B
MA-SA-65

						
HEXO 6A	MA-SA-67	4,25 x 4,41	6,67 x 6,91	0,90	3+	6
HEXO 4A	MA-SA-64	4,25 x 4,41	6,91 x 6,67	0,90	3+	4
HEXO 3A	MA-SA-62	1,70 x 4,41	4,12 x 6,91	0,90	3+	3
HEXO 3B	MA-SA-63	2,94 x 2,97	5,44 x 5,39	0,90	3+	3
HEXO 5A	MA-SA-66	4,25 x 2,94	6,67 x 5,44	0,90	3+	5
HEXO 4B	MA-SA-65	4,25 x 3,68	6,67 x 6,18	0,90	3+	4
HEXO 13A	MA-SA-69	6,80 x 7,36	9,22 x 9,86	0,90	3+	13
HEXO 7A	MA-SA-68	4,25 x 4,42	6,67 x 6,91	0,90	3+	7



HEXO 13A
MA-SA-69



HEXO 7A
MA-SA-68





TUTO 1
MA-SA-101



TUTO 2
MA-SA-102



TUTO 3
MA-SA-103









TUTO 4
MA-SA-104



TUTO 5
MA-SA-105



TUTO 6
MA-SA-106

						
TUTO 1	MA-SA-101	1,75 x 4,65	4,25 x 7,15	0,90	3+	3
TUTO 2	MA-SA-102	3,81 x 4,20	6,69 x 6,30	0,90	3+	4
TUTO 3	MA-SA-103	2,97 x 3,20	5,47 x 5,69	0,90	3+	3
TUTO 4	MA-SA-104	3,91 x 3,91	5,42 x 5,42	0,90	3+	5
TUTO 5	MA-SA-105	1,25 x 3,75	3,75 x 6,25	0,90	3+	3
TUTO 6	MA-SA-106	3,00 x 3,00	5,50 x 5,50	0,90	3+	4
TUTO 7	MA-SA-107	4,00 x 4,00	6,50 x 6,50	0,90	3+	5
TUTO 8	MA-SA-108	1,75 x 8,04	4,75 x 11,05	0,90	3+	5
TUTO 9	MA-SA-109	2,12 x 5,65	4,05 x 7,95	0,90	3+	3



TUTO 7
MA-SA-107









TUTO 8
MA-SA-108



TUTO 9
MA-SA-109





						
TUTO 10	MA-SA-110	2,25 x 8,00	4,75 x 10,50	0,90	3+	6
TUTO 11	MA-SA-111	3,00 x 4,50	5,50 x 7,00	0,90	3+	6
TUTO 12	MA-SA-112	4,50 x 4,50	7,00 x 7,00	0,90	3+	9
TUTO 13	MA-SA-113	3,00 x 3,00	5,50 x 5,50	0,90	3+	4
TUTO 14	MA-SA-114	3,50 x 3,50	6,00 x 6,00	0,90	3+	4
TUTO 15	MA-SA-115	3,00 x 6,00	5,50 x 8,50	0,90	3+	8
TUTO 16	MA-SA-116	3,00 x 4,50	5,50 x 7,00	0,90	3+	6
TUTO 17	MA-SA-117	3,00 x 3,00	5,50 x 5,50	0,90	3+	4
TUTO 18	MA-SA-118	3,00 x 6,00	5,50 x 8,50	0,90	3+	6



TUTO 10
MA-SA-110



TUTO 11
MA-SA-111



TUTO 12
MA-SA-112



TUTO 13
MA-SA-113



TUTO 14
MA-SA-114



TUTO 15
MA-SA-115



TUTO 16
MA-SA-116



TUTO 17
MA-SA-117



TUTO 18
MA-SA-118



TUTO 19
MA-SA-119



TUTO 20
MA-SA-120



TUTO 21
MA-SA-121



TUTO 22
MA-SA-122



TUTO 23
MA-SA-123



TUTO 24
MA-SA-124



TUTO 25
MA-SA-125



TUTO 26
MA-SA-126



TUTO 27
MA-SA-127



TUTO 19	MA-SA-119	3,00 x 7,50	5,50 x 10,00	0,90	3+	8
TUTO 20	MA-SA-120	6,00 x 7,50	8,50 x 10,00	0,90	3+	10
TUTO 21	MA-SA-121	4,50 x 9,00	7,00 x 11,50	0,90	3+	10
TUTO 22	MA-SA-122	4,50 x 4,50	7,00 x 7,00	0,90	3+	8
TUTO 23	MA-SA-123	7,50 x 7,50	10,00 x 10,00	0,90	3+	15
TUTO 24	MA-SA-124	9,00 x 9,00	11,50 x 11,50	0,90	3+	20
TUTO 25	MA-SA-125	10,50 x 10,50	13,00 x 13,00	0,90	3+	27
TUTO 26	MA-SA-126	7,50 x 10,50	10,00 x 13,00	0,90	3+	25
TUTO 27	MA-SA-127	10,50 x 10,50	13,00 x 13,00	0,90	3+	33





TUTO 28
MA-SA-128



TUTO 29
MA-SA-129



TUTO 30
MA-SA-130









TUTO 31
MA-SA-131



TUTO 32
MA-SA-132



TUTO 33
MA-SA-133

							
TUTO 28	MA-SA-128	11,70 x 3,38	13,99 x 5,88	0,90	3+	10	
TUTO 29	MA-SA-129	10,50 x 4,50	13,00 x 6,93	0,90	3+	11	
TUTO 30	MA-SA-130	10,50 x 3,00	13,00 x 5,44	0,90	3+	11	
TUTO 31	MA-SA-131	7,50 x 3,00	10,00 x 5,50	0,90	3+	7	
TUTO 32	MA-SA-132	3,2 x 3,2 m	5,7 x 5,7 m	0,9	3+	4	
TUTO 33	MA-SA-133	5,17 x 4,17	7,67 x 6,67 m	0,9	3+	8	



OUTDOOR GAMES

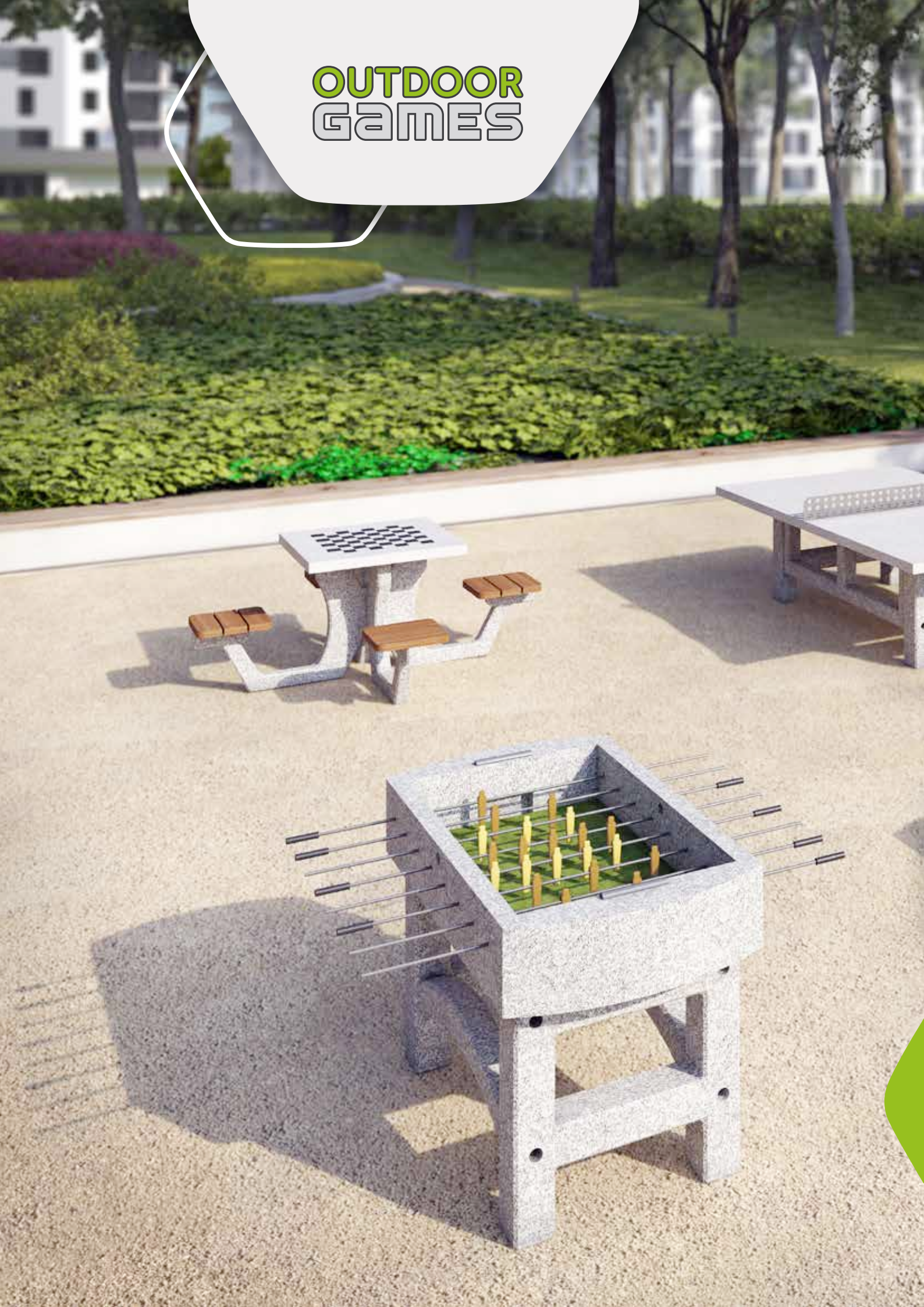





TENNIS TABLE 01/02
TISCHTENNISPLATTE 01/02
KT-02-CR-007/008

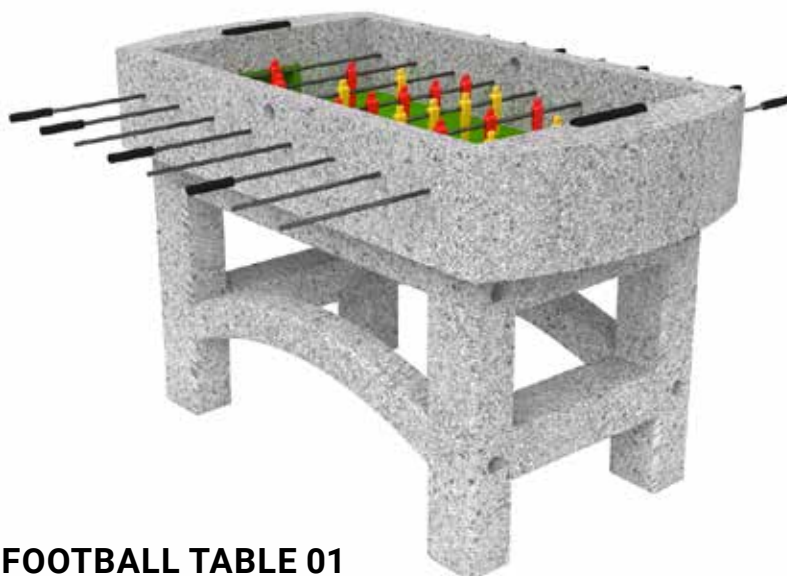

FOOTBALL TABLE 01
KICKERTISCH 01
KT-02-CR-009



TENNIS TABLE 01/02

KT-02-CR-007/008

2,74 x 1,52 x 0,78

FOOTBALL TABLE 01

KT-02-CR-009

1,52 x 0,80 x 0,88

TABLE FOR CHESS - CHECKERS 01

KT-02-CR-001

2,00 x 2,00 x 0,81

PICNIC TABLE 01

KT-02-CR-011

2,00 x 2,00 x 0,81

PICNIC TABLE 02

KT-02-CR-012

2,00 x 2,00 x 0,78

Concrete games tables | Spieltische aus Beton



**TABLE FOR CHESS -
CHECKERS 01**
KT-02-CR-001



TABLE FOR LUDO GAME 01
KT-02-CR-002



PICNIC TABLE 01
KT-02-CR-011



PICNIC TABLE 02
KT-02-CR-012



**TABLE FOR CHESS - CHECKERS 03**

T-02-CR-005

**PICNIC TABLE 03**

KT-02-CR-013

**TABLE FOR LUDO GAME 03**

KT-02-CR-006



TABLE FOR CHESS - CHECKERS 03	KT-02-CR-005	2,00 x 2,00 x 0,83	-
PICNIC TABLE 03	KT-02-CR-013	2,00 x 2,00 x 0,83	-
TABLE FOR LUDO GAME 03	KT-02-CR-006	2,00 x 2,00 x 0,83	-
TABLE FOR CHESS - CHECKERS / LUDO GAME	KT-02-CR-010	2,00 x 2,00 x 0,78	-
TABLE FOR CHESS - CHECKERS 02	KT-02-CR-003	2,00 x 2,00 x 0,78	-
TABLE FOR LUDO GAME 02	KT-02-CR-004	2,00 x 2,00 x 0,78	-



**TABLE FOR CHESS -
CHECKERS / LUDO GAME 02**
KT-02-CR-010



TABLE FOR CHESS - CHECKERS 02
KT-02-CR-003



TABLE FOR LUDO GAME 02
KT-02-CR-004

URBAN FURNITURE





TOPAZO

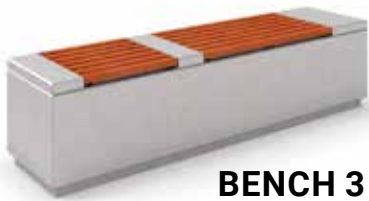

BENCH 3

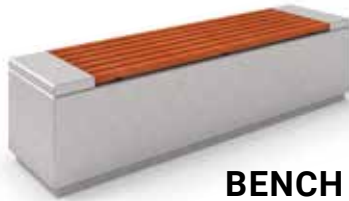

BENCH 2



BENCH 4



BENCH 1

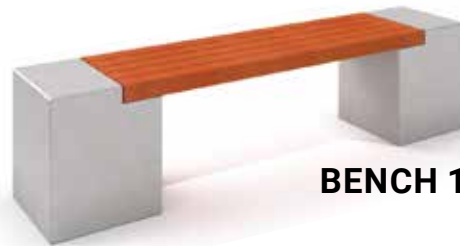

BENCH 11



BENCH 5



BENCH 7



TRASH BIN 5



ARMITA



BENCH 9

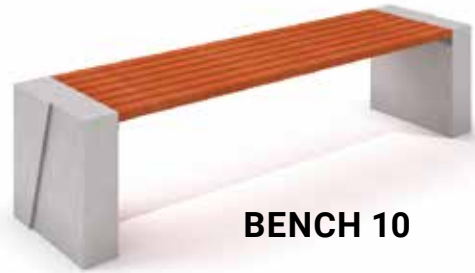

BENCH 10



TABLE 2



TRASH BIN 1



KRETO



BENCH 5



BENCH 6



TRASH BIN 7

PERLO

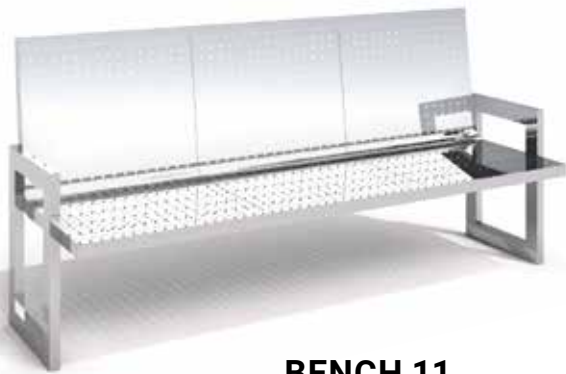

BENCH 11

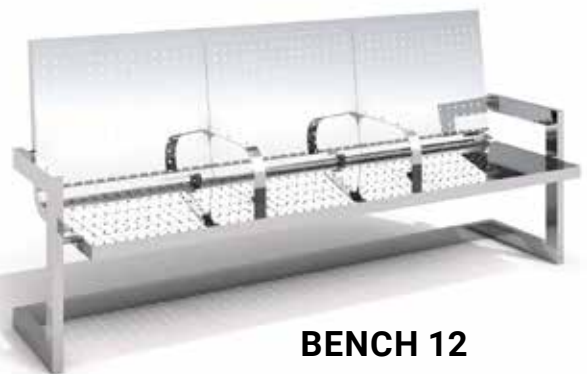

BENCH 12



BICYCLE RACK 24



TRASH BIN 6

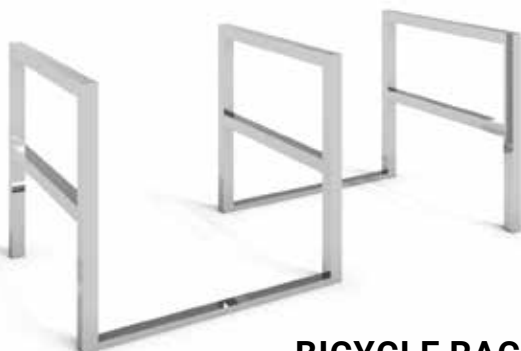

BICYCLE RACK 6



TRASH BIN 7

MALAKITO

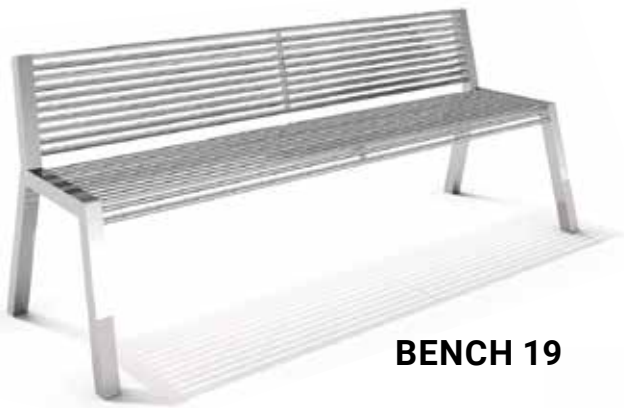

BENCH 19



BENCH 20



TRASH BIN 4



JAGO



BENCH 16



BENCH 17

TRASH BIN 7



TRASH BIN 5

TRASH BIN 6



BICYCLE RACK 8



BICYCLE RACK 10



BICYCLE RACK 26

SAFIRO



BENCH 5



BENCH 6



BENCH 7



TRASH BIN 1



TRASH BIN 2



BICYCLE RACK 6

KRONO



BENCH 21



BENCH 15



BENCH 3



BICYCLE RACK 2



BICYCLE RACK 8



BICYCLE RACK 1



Benches made of Deco concrete | Sitzbänke aus Dekobeton



DECO CONCRETE BENCH 1



DECO CONCRETE BENCH 2



DECO CONCRETE BENCH 3



DECO CONCRETE BENCH 4



DECO CONCRETE BENCH 5



DECO CONCRETE BENCH 6



DECO CONCRETE BENCH 7



DECO CONCRETE BENCH 8



DECO CONCRETE BENCH 9



DECO CONCRETE BENCH 10



DECO CONCRETE BENCH 11



DECO CONCRETE BENCH 12



DECO CONCRETE BENCH 13



DECO CONCRETE BENCH 14

Concrete benches | Sitzbänke aus gewaschenem Beton



CONCRETE BENCH 1



CONCRETE BENCH 2



CONCRETE BENCH 5



CONCRETE BENCH 6



CONCRETE BENCH 7



CONCRETE BENCH 8



CONCRETE BENCH 9



CONCRETE BENCH 3



CONCRETE PLANTER SET WITH BENCH 1



CONCRETE PLANTER SET WITH BENCH 2



CONCRETE PLANTER SET WITH BENCH 3



CONCRETE BENCH 4



CONCRETE PLANTER SET WITH BENCH 1



CONCRETE PLANTER SET WITH BENCH 2



CONCRETE PLANTER SET WITH BENCH 3

Stainless steel and steel benches | Edelstahl Sitzbänke



STAINLESS STEEL BENCH 1



STAINLESS STEEL BENCH 2



STAINLESS STEEL BENCH 3



STAINLESS STEEL BENCH 4



STAINLESS STEEL BENCH 5



STAINLESS STEEL BENCH 6



STAINLESS STEEL BENCH 7



STAINLESS STEEL BENCH 8



STAINLESS STEEL BENCH 9



STAINLESS STEEL BENCH 10



STAINLESS STEEL BENCH 11



STAINLESS STEEL BENCH 12



STAINLESS STEEL BENCH 13



STAINLESS STEEL BENCH 14



STAINLESS STEEL BENCH 15



STAINLESS STEEL BENCH 16



STAINLESS STEEL BENCH 17



STAINLESS STEEL BENCH 18



STAINLESS STEEL BENCH 19



STAINLESS STEEL BENCH 20



STAINLESS STEEL BENCH 21



Decorative trash bins made of Deco concrete | Mülleimer aus Dekobeton



DECO WHITE CONCRETE TRASH BIN 1



DECO WHITE CONCRETE TRASH BIN 2

Concrete trash bins | Mülleimer aus gewaschenem Beton



CONCRETE TRASH BIN 1



CONCRETE TRASH BIN 2



CONCRETE TRASH BIN 3



CONCRETE TRASH BIN 4



CONCRETE TRASH BIN 5



CONCRETE TRASH BIN 6



CONCRETE TRASH BIN 7

Stainless steel and steel trash bins | Edelstahl Mülleimer



STAINLESS STEEL TRASH BIN 8



STAINLESS STEEL TRASH BIN 1



STAINLESS STEEL TRASH BIN 2



STAINLESS STEEL TRASH BIN 3



STAINLESS STEEL TRASH BIN 4



STAINLESS STEEL TRASH BIN 5



STAINLESS STEEL TRASH BIN 6



STAINLESS STEEL TRASH BIN 7



Stainless steel and steel bicycle racks | Edelstahl Fahrradständer



**STAINLESS STEEL
BICYCLE RACK 1**



**STAINLESS STEEL
BICYCLE RACK 2**



**STAINLESS STEEL
BICYCLE RACK 4**



**STAINLESS STEEL
BICYCLE RACK 5**



**STAINLESS STEEL
BICYCLE RACK 6**



**STAINLESS STEEL
BICYCLE RACK 7**



**STAINLESS STEEL
BICYCLE RACK 8**



**STAINLESS STEEL
BICYCLE RACK 10**



**STAINLESS STEEL
BICYCLE RACK 11**



**STAINLESS STEEL
BICYCLE RACK 12**



**STAINLESS STEEL
BICYCLE RACK 13**



**STAINLESS STEEL
BICYCLE RACK 14**

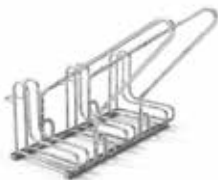

**STAINLESS STEEL
BICYCLE RACK 15**



**STAINLESS STEEL
BICYCLE RACK 16**

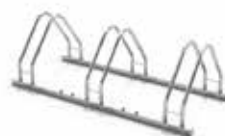

**STAINLESS STEEL
BICYCLE RACK 17**



**STAINLESS STEEL
BICYCLE RACK 18**

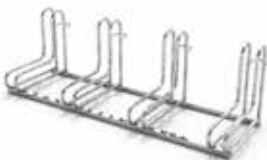

**STAINLESS STEEL
BICYCLE RACK 19**



**STAINLESS STEEL
BICYCLE RACK 20**

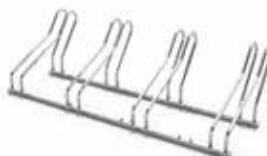

**STAINLESS STEEL
BICYCLE RACK 21**



**STAINLESS STEEL
BICYCLE RACK 22**



**STAINLESS STEEL
BICYCLE RACK 24**



**STAINLESS STEEL
BICYCLE RACK 25**



**STAINLESS STEEL
BICYCLE RACK 26**



A VOTRE SERVICE DEPUIS 1995



English

direction@healthsport.ch

+41 21 903 57 67

<https://healthsport.ch/>

Deutschland / Österreich

direction@healthsport.ch

+41 21 903 57 67

<https://healthsport.ch/>